

BUILT-IN CERAMIC HOB

Model:

HB AV 231 A

HB AV 461 A

HB AV 271 A



THE BEAUTY OF SIMPLICITY



USER MANUAL

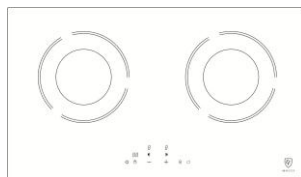
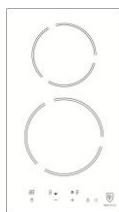
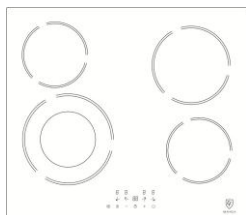

Safety Warning

Please read this user manual thoroughly before attempting to use this appliance for the first time. This manual contains important information on safe installation, use and care of the appliance. Keep these instructions for reference and pass them on to future user.

IMPORTANT: This appliance is designed and manufactured solely for the cooking of domestic (household) food and is not suitable for any non-domestic application and therefore should not be used in a commercial environment.

The appliance guarantee will be void if the appliance is used within a non-domestic environment i.e. A semi commercial, commercial or a communal environment.

Installation

Electrical Shock Hazard

- Disconnect the appliance from the mains electricity supply before carrying out any work or maintenance on it.
 - Connection to a good earth wiring system is essential and mandatory.
1. Means for disconnection must be incorporated in the fixed wiring in accordance with the wiring rules.
- Alterations to the domestic wiring system must only be made by a qualified electrician.
 - Failure to follow this advice may result in electrical shock or death.

Cut Hazard

- Panel edges are sharp – be careful
- Failure to use caution could result in injury or cuts.

Important Safety Instructions

- After having unpacked the appliance, check to ensure that it is not damaged.
- No combustible material or products should be placed on this appliance at any time.
- In order to avoid hazard, this appliance must be installed according to the instructions for installation.
- This appliance is to be properly installed and earthed only by a suitably qualified person.

- Do not attempt to modify the technical characteristics of the appliance as this may become dangerous to use.
- This appliance should be connected to a circuit which incorporates an isolating switch providing full disconnection from the power supply.
- **WARNING:** Use only hob guards designed by the manufacturer of this appliance on the instructions for use. The use of inappropriate guards can cause accidents.
- Failure to install the appliance correctly could invalidate any warranty or liability claims.
- Regarding the details of installation, please refer to the section <Installation>.

Operation and Maintenance

Electrical Shock Hazard

- Do not cook on a broken or cracked cooktop. If the cooktop surface is broken or cracked, switch the appliance off immediately at the main power supply (wall switch) to avoid the possibility of electric shock, for hob surfaces of glass-ceramic or similar material which protect live parts and contact customer service center.
- Switch the cooktop off at the wall before cleaning or maintenance.
- Failure to follow this advice may result in electrical shock or death.

Health Hazard

- This appliance complies with electromagnetic safety standards.
- **WARNING:** Persons with cardiac pacemakers or any other electrical implants must check with their doctor if they can use the induction cooking system.

Hot Surface Hazard

- During use, the appliance and its accessible parts will become hot. Care should be taken to avoid touching the heating elements.
- Do not let your body, clothing or any item other than suitable cookware contact the ceramic glass until the surface is cool down.
- Children less than 8 years of age shall be kept away unless continuously supervised.
- Metallic objects such as knives, forks, spoons and lids should not be placed on the hob surface since they can get hot.

- Handles of saucepans may be hot to touch. Check saucepan handles do not overhang other cooking zones that are on. Keep handles out of children.
- Failure to follow this advice could result in burns and scalds.

Important Safety Instructions

- Never use the appliance as a work or storage surface.
- Never leave any objects or utensils on the appliance.
- Never use the appliance for warming or heating the room.
- After use, always turn off the cooking zones and the cooktop as described in this manual (i.e. by using the touch controls).
- The appliance is not intended to be operated by means of an external timer or separate remote-control system.
- Do not allow children to play with the appliance or sit, stand, or climb on it.
- Do not leave children alone or unattended in the area where the appliance is in use.
- Do not stand on the appliance.
- Do not repair or replace any part of the appliance unless specifically recommended in the manual. All other servicing should be done by a qualified technician.
- Do not use a steam cleaner to clean your cooktop as the moisture can get into the appliance therefore making it unsafe
- Do not place or drop heavy or sharp objects on the glass ceramic hob
- Do not use pans with jagged edges or drag pans across the glass surface as this can scratch the glass.
- Do not use scourers or any other harsh abrasive cleaning agents to clean your cooktop, as these can scratch the ceramic glass.
- If the supply cord is damaged, it must be replaced by the manufacturer, its service agent or similarly qualified persons in order to avoid hazard.
- This appliance can be used by children aged from 8 years and above and persons with reduced physical, sensory or mental capabilities or lack of experience and knowledge if they have been given supervision or instruction concerning use of the appliance in a safe way and understand the hazards involved.
- **WARNING:** Unattended cooking on a hob with fat or oil can be dangerous and may result in fire. NEVER try to extinguish a fire with water, but switch off the appliance and then cover flame e.g. with a lid or a fire blanket.
- **WARNING:** Danger of fire: do not store items on the cooking surfaces.

Product Overview

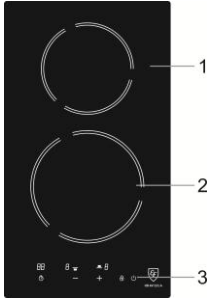

HB AV 231 A

1. \varnothing 165mm / 1200W zone
2. \varnothing 200mm / 1800W zone
3. Control panel

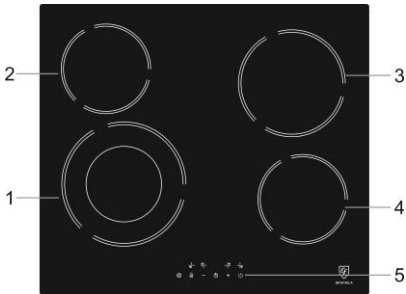

HB AV 461 A

1. \varnothing 140/230mm / 1100-2200W zone
2. \varnothing 165mm / 1200W zone
3. \varnothing 200mm / 1800W zone
4. \varnothing 165mm / 1200W zone
5. Control panel



HB AV 271 A

1. \varnothing 140/230mm / 1100-2200W zone
2. \varnothing 140/230mm / 1100-2200W zone
3. Control panel

Control Panel

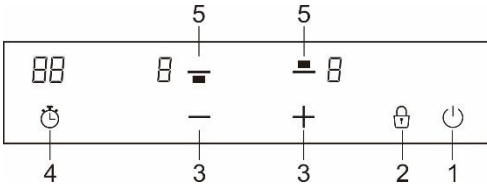

HB AV 231 A

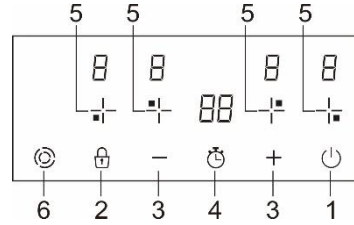

HB AV 461 A

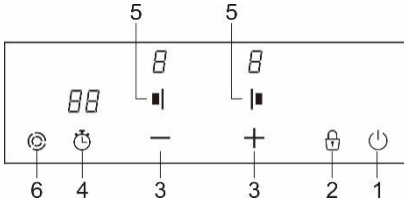

HB AV 271 A

- | | |
|------------------------|---------------------|
| 1. ON/OFF control | 2. Key lock control |
| 3. Select power level | 4. Timer control |
| 5. Select heating zone | 6. Dual zone |

Use of Ceramic Hob

Before using the ceramic hob

- Read this guide, taking special note of the 'Safety Warnings' section.
- Remove any protective film that may still be on your Induction hob.

Touch Control

- The control respond to touch, so you don't need to apply any pressure.
- Use the ball of your finger, not its tip.
- You will hear a beep sound each time a touch is registered.
- Make sure the control is always clean, dry and that there is no object (e.g. a utensil or a cloth) covering them. Even a thin film of water may make the control difficult to operate.

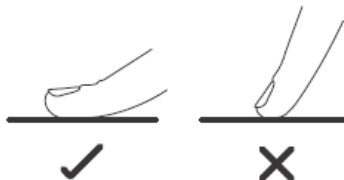

Do not use cookware with jagged edges or a curved base.



Make sure that the base of your pan is smooth, sits flat against the glass, and is the same size as the cooking zone. Always center your pan on the cooking zone.

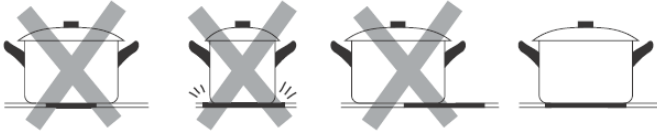

Always lift pans off the ceramic hob – do not slide, or they may scratch the glass.

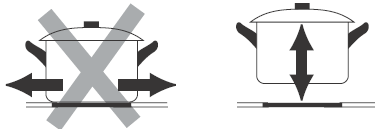

Note: Some type of cookware may cause noise during cooking – the noise is normal and does not mean any malfunction of the appliance.

Operation

To start cooking

Turn on the main power supply, the buzzer beeps once and all the indicators light up for 1 second then goes off, indicating that the hob has entered the state of standby mode.

1. Touch the ON/OFF  control. All the indicators show “-”



2. Place a suitable pan on the desired cooking zone
(Make sure the bottom of the pan and the surface of the cooking zone is clean and dry.)



3. Select the cooking zone by touching the relevant heating zone, the power level on the selected zone will flash.
The default power level setting is 5.

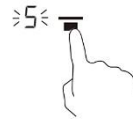

4. Adjust the heat setting by touching the key “+” or “-”. If the heat setting is not chosen within 1 minute, the cooktop will automatically switch off. Restart the cooktop from Step 1



Note: You can modify the heat setting at any time during cooking.

If a cooking zone is not turned on within 1 minute, the ceramic hob will automatically switch off. You will need to start again at step 1.

To end cooking

1. Select the desired heating zone



2. Turn the cooking zone off by setting the power level to “0”.
Make sure the display shows “0”.



3. Turn the whole cooktop off by touching the ON/OFF control.



Note: Beware of hot surfaces

“H” will be lighted for cooking zone which is hot to touch. It will be turned off when the cooking zone temperature drop below a preset temperature. It can also be used as an energy saving function as you can heat up the pans by using the residual heat



Dual Zone Function

The dual zone consists of 2 circuits - the center zone and the outer zone. It can be used in the following modes:

- Center Zone – only first heating unit is turned on
- Extended Zone (Center + Outer) – Both first and second heating circuits are turned on

Upon selecting the cooking zone, only the center zone will be turned ON. To activate the outer zone:

- Touch the selected cooking zone with dual zone function
- Touch dual zone key  , the indicator display will show “=”



To cancel the outer zone, press the dual zone key  to turn off the second heating circuit, then select the desired power level by using keys “+” and “-”

Power Management

Power Sharing between cooking zones (For HB AV 271 A only)

- If using dual zone function, the power management shares the maximum available power between two cooking zones.
- As soon as the extended zone is turned on, the power management will not allow all both zones to operate at full power but will alternate power between the 2 cooking zones so the total power will be equal to the preset maximum power. The change will be visible on both displays. The last command given to a cooking zone takes priority on the power setting.

Safety Key-Lock

This function locks the touch control keys to prevent unintended use, for example, children accidentally turn the cooking zones on.

When the controls are locked, all the controls except the ON/OFF key are disabled.

To activate the key-lock

- Touch the key lock  control once the timer indicator will show “Lo” and the key-lock is activated.

To deactivate the key-lock

- Make sure the cooktop is turned on.
- Touch and hold the key lock control  for 3 seconds.



When the hob is in lock mode, all the controls are disabled except the ON/OFF key, you can always turn off the hob with the ON/OFF control. To use the cooktop after it is switched off, key-lock protection has to be deactivated first.

Residual Heat Warning

When turning off the cooking zone (level “0”) after operating for some times, there will be some residual heat and the cooking zone will become too warm to be touched. The letter “H” will be shown as a warning. Avoid touching the cooking zone until the temperature drops to a safe temperature and the letter “H” is turned off.

H

Overflow Protection

When the liquid flows to the control panel, the hob will automatically shut down within 10 seconds.

To restart, turn off the power and wipe the area with a clean towel before using.

Auto Switch Off

Auto switch off is a safety feature. Each cooking zone is switched off automatically after a maximum preset time if no further operation is performed. The maximum preset time limit depends on the set power level and the default cooking times are shown in the table below:

Power level	1	2	3	4	5	6	7	8	9
Operation time limit (hour)	8	8	8	4	4	4	2	2	2

Timer Function

The timer can be used in two different ways:

- As a minute minder - the timer will not turn any cooking zone off when the set time is up. It is function as a reminder or alarm.
- As an automatic switch off timer - to turn one or more cooking zones off after the set time is up.
- In both ways, the timer can be set from "01" to "99" minutes.

Using the Timer as a Minute Minder

The minute minder can be activated if there is no cooking zone selected

1. Make sure that the cooktop is turned on.

Note: The minute minder can be activated before or after cooking zone setting is finished.

2. Touch the timer control, the timer display will show "10" and the second digit "0" will flash.

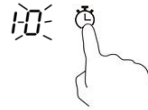

3. Set the time by using the keys "+" and "-" (e.g. set the second digit as "5")

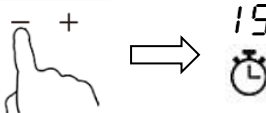

4. Touch the timer control again, the first digit "1" will flash.



5. Set the time by using the keys "+" and "-" (e.g. set the first digit as "9") and the timer will be set at 95 minutes.

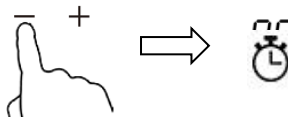

6. When the time is set, it will begin to count down immediately. The display will show the remaining time.

7. Buzzer will beep for 30 seconds and the time display will show "--" when the setting time is up. The cooking zone will keep operating.



Using the Timer as an Cooking Timer

If the timer is set on one zone:

1. Select the heating zone and set the desired power level.



2. Touch the timer control, the timer display will show "10" and the second digit "0" will flash.



3. Set the time by using the keys "+" and "-" (e.g. set the second digit as "5")



4. Touch the timer control again, the first digit "1" will flash.

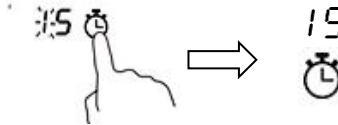

5. Set the time by using the keys "+" and "-" (e.g. set the first digit as "9"), and the time will be set at 95 minutes.

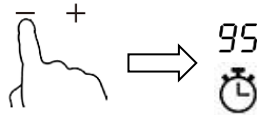

6. When the time is set, it will begin to count down immediately. The display will show the remaining time.

NOTE: The red dot next to the power level indicator will be lighted, indicating that relevant zone is selected for timer



7. When cooking timer is ended, the relevant cooking zone will switch off automatically and other cooking zones will keep operating if they are turned on previously.



NOTE: The time can be changed at any time by touching the timer control key.

If the timer is set on multiple cooking zone:

- It is possible to set the cooking timer for multiple cooking zone simultaneously. To program the timer on another cooking zone, repeat the steps as described above.
- When multiple timer is activated, there will be red dot shown on each relevant cooking zones. The timer display will show the shortest or minimum time set among the cooking zones and the red dot of the corresponding zone will flash. For example, if the timer is set to 15 minutes for one zone and 45 minutes for the other zone, the timer display will show 15 minutes (shortest between the 2 set zones) and the red dot of the corresponding zone will flash.



- Once the countdown is ended, the corresponding zone will switch off automatically. The timer display will show the next minimum time set (in this case, 30 minutes) and the red dot of the corresponding zone will flash.



NOTE: Touch the heating zone selection control at any time, the corresponding timer for the selected zone will be shown in the timer display

Cancel the timer

- Select the relevant cooking zone.



- Touch the timer control, the power indicator will flash



- Reset the time to "00" using the keys "+" and "-" and the timer will be cancelled

Heat Settings

Heat Setting	Suitability
1 - 2	<ul style="list-style-type: none">• delicate warming for small amounts of food• melting chocolate, butter and food that burn quickly• gentle simmering• slow warming
3 - 4	<ul style="list-style-type: none">• reheating• simmering
5 - 6	<ul style="list-style-type: none">• slow boiling• continuations of steam cooking of roasts, stews
7 - 8	<ul style="list-style-type: none">• frying• browning of meats• boiling of water
9	<ul style="list-style-type: none">• fast frying• fast boiling• grilled steaks

Care and Cleaning

Problem	Action	Remarks
Soiling on glass (finger-prints, marks, stains left by food or non-sugary spillovers on the glass)	<ol style="list-style-type: none"> 1. Switch off the main power of the cooktop off. 2. Apply a cooktop cleaner while the glass is still warm (but not hot!) 3. Rinse and wipe dry with a clean cloth or paper towel. 4. Switch the power on. 	<ul style="list-style-type: none"> • When the power of the cooktop is switched off, there will be no 'hot surface' indication but the cooking zone may still be hot! Take extreme care. • Heavy-duty scourers, some nylon scourers and harsh/abrasive cleaning agents may scratch the glass. Always read the label to check if the cleaner or scourer is suitable. • Never leave cleaning residue on the cooktop: the glass may become stain
Boil overs, melts, and hot sugary spills on the glass	<p>Remove these immediately with a fish slice, palette knife or razor blade scraper suitable for ceramic glass cooktops, but beware of hot cooking zone surfaces:</p> <ol style="list-style-type: none"> 1. Switch off the main power 2. Hold the blade or utensil at a 30° angle and scrape the soiling or spill to a cool area of the cooktop. 3. Clean the soiling or spillages with a dish cloth or paper towel. 4. Follow steps 2 to 4 for 'Soiling on glass as above. 	<ul style="list-style-type: none"> • Stains must be removed as soon as possible. If the stain remains unclean and become harden, it will be difficult to remove or even permanently damage the glass surface. • Cut hazard: when the safety cover is retracted, the blade in a scraper is razor-sharp. Use with extreme care and always store safely and keep out of reach of children.
Spillovers on the touch controls	<ol style="list-style-type: none"> 1. Switch off the main power. 2. Wipe the touch control area with a clean damp sponge or cloth. 3. Wipe the area completely dry with a paper towel. 4. Switch the power on. 	<ul style="list-style-type: none"> • The cooktop may beep and turn off. The touch controls may not function while there is liquid on it. Make sure you wipe the touch control area dry before turning the cooktop power on.

Trouble Shooting

Problem	Possible causes	Action
The cooktop cannot be turned on.	<ul style="list-style-type: none"> No power. 	<ul style="list-style-type: none"> Make sure the cooktop is connected to the power supply and is switched on. Check whether there is a power outage in your home or area. If problem persists, call customer service center.
The touch controls are not responsive.	<ul style="list-style-type: none"> The controls are locked. 	<ul style="list-style-type: none"> Unlock the controls. See section ‘Safety Key-lock’ for instructions.
The touch controls are difficult to operate.	<ul style="list-style-type: none"> There may be a spillage of water over the controls or you may be using the tip of your finger when touching the controls. 	<ul style="list-style-type: none"> Make sure the touch control area is dry Use the ball of your finger when touching the controls.
Scratch mark on the surface	<ul style="list-style-type: none"> Rough-edged cookware. Unsuitable, abrasive scourer or cleaning products being used. 	<ul style="list-style-type: none"> Use cookware with flat and smooth base. See ‘Choosing the right cookware’. See ‘Care and cleaning’.
Some cookware make crackling or clicking noises.	<ul style="list-style-type: none"> This may be caused by the construction of your cookware (layers of different metals vibrating differently). 	<ul style="list-style-type: none"> This is normal and does not indicate a fault.
The hob makes a low humming noise when used on a high heat setting.	<ul style="list-style-type: none"> This is due to the normal operation of the electronic control system 	<ul style="list-style-type: none"> This is normal but the noise should be reduced or disappear completely the heat setting is reduced.

Technical Specification

Ceramic Hob		HB AV 231 A
Cooking Zones		2 Zones
Supply Voltage		220-240V~
Installed Electric Power		3000W
Product Dimensions	L×W×H(mm)	290×520×50
Built-in Dimensions	L×W (mm)	270X490

Ceramic Hob		HB AV 461 A
Cooking Zones		4 Zones
Supply Voltage		220-240V~
Installed Electric Power		6400W
Product Dimensions	L×W×H(mm)	590×520×50
Built-in Dimensions	L×W (mm)	560X490

Ceramic Hob		HB AV 271 A
Cooking Zones		2 Zones
Supply Voltage		220-240V~
Installed Electric Power		3300W
Product Dimensions	L×W×H(mm)	730×420×50
Built-in Dimensions	L×W (mm)	680X380

Weight and Dimensions are approximate. Specifications and designs subjected to change without prior notice.

Advice for the Installer

Installation

IMPORTANT:

- The cooktop is to be installed only by authorized person according to the current local regulations and in observation of the manufacturer's instructions.
- Incorrect installation, for which the manufacturer accepts no responsibility, may cause personal injury or damage.
- Always disconnect the cooktop from mains power supply before carrying out any maintenance operations or repairs

Product Dimensions

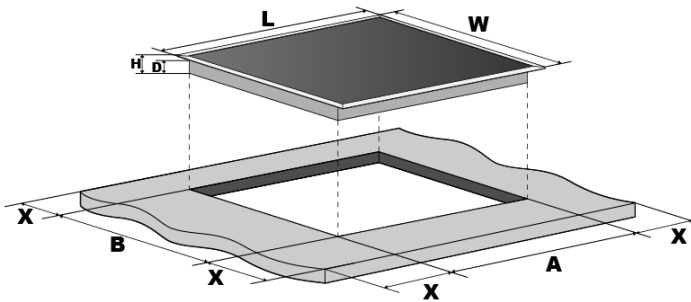

Fig 1

	L(mm)	W(mm)	H(mm)	D(mm)	A(mm)	B(mm)	X(mm)
HB AV 231 A	290	520	50	46	270	490	Min 50
HB AV 461 A	590	520	50	46	560	490	Min 50
HB AV 271 A	730	420	50	46	680	380	Min 50

Selection of Installation Equipment

- The cooktop must be housed in heat-resistant work surface to avoid large deformation caused by the heat radiation.
- Cut the work surface according to the dimension shown in the above table (Fig.1)
- A minimum of 50mm space shall be kept around the hole (refer to “X” in Fig.1)
- Be sure the thickness of the work surface is at least 30mm.
- The base of the cooktop must have direct unrestricted ventilation to the room where the cooktop is installed. Follow the requirement of figure 2.



Under any circumstances, make sure the cooktop is well ventilated and the air inlet and outlet are not blocked. Ensure the cooktop is in good work state.

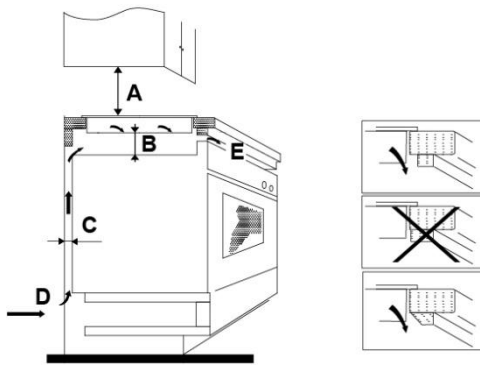

Fig.2

A	B	C	D	E (Air Exit)
600 mm	Min 50 mm	Min 20 mm	Air Intake	Min 5mm

Note: The safe distance between the cooktop and any wall cupboard or cookerhood positioned immediate above the cooktop should be at least 600mm.

Before installing the hob, make sure that

- The work surface is heat-resistant, square and level and no structural members interfere with space requirements.
- If the hob is installed above an oven, the oven should have a built-in cooling fan. The two appliances should be connected to the electrical supply with independent connections.
- The cooktop cannot be installed directly above cooling equipment, dishwasher or clothes dryers as the humidity may damage the cooktop electronic system.
- There is adequate air flow for the cooktop to fully function – the base of the cooktop must have direct unrestricted ventilation to the room where the cooktop is installed.

- To use heat-resistant and easy-to-clean finishes (such as ceramic tiles) for the wall surfaces surrounding the hob.
- If the hob is installed above a drawer or cupboard space, a thermal protection barrier is installed below the base of the hob.
- The installation shall comply with all clearance requirements and applicable standards and regulations.
- An approved isolating switch providing full disconnection from the main power supply is incorporated in the permanent wiring, mounted and positioned to comply with the local wiring rules and regulations.
- The isolating switch will be easily accessible to the customer with the hob installed.
- To consult local building authorities and by-laws if in doubt regarding installation.

Fastening the Cooktop

Each ceramic hob is supplied with a set of installation fixtures to fasten it on units with a working surface from 30 to 50 deep.

Brackets x 4pc

Screws x 4pc

Sealing Strip x 1pc

- Turn the cooktop upside down and rest the glass side on a cloth.
- Spread the sealing strip around the edge of the hob.
- Put the brackets into the mountings by using screws (do not fully tightened) (Fig.3)
- Place the cooktop into the cut-out hole and position it properly.
- Adjust the brackets to the correct position and tighten the screws until the cooktop is fully secured.
- Remove any excessive seal which protrudes from the cooktop. Take care not to damage the work surface.

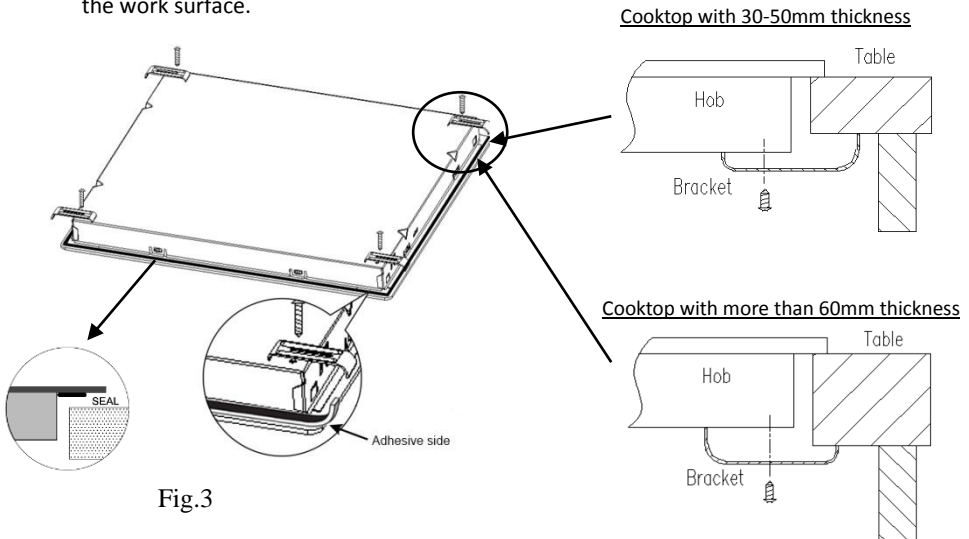

Electrical Connection

The power supply should be connected in compliance with the relevant standard, or a single-pole circuit breaker. The method of connection is shown below.

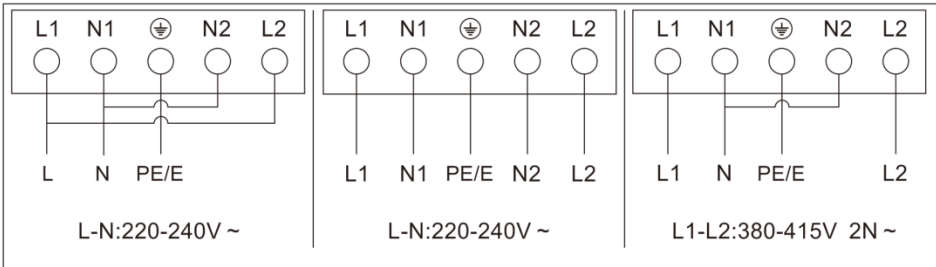

- Electric power connection shall be carried out only by a qualified personnel
- The cooktop must be connected to the mains checking that the voltage corresponds to the value given in the rating plate and that the electrical cable sections can withstand the load specified on the plate.
- If the appliance is being connected directly to the mains power supply, an omnipolar circuit breaker must be installed with a minimum gap of 3mm between the contacts.
- The cable must not near or touch any hot parts and must be positioned in such way that it does not exceed 50°C above ambient.
- If the cable is damaged or needs replacing, this should be done by an after-sales technician using proper tools.
- The cable must not be bent or compressed.
- The cable must be checked regularly and only replaced by a qualified personnel.

Note: Never use adaptors, reductions or multiple power points for electric power connection as these may overheat and catch fire



DISPOSAL: Do not dispose this product as unsorted municipal waste. Collection of such waste separately for special treatment is necessary.

This appliance is labeled in compliance with European directive 2002/96/EC for Waste Electrical and Electronic Equipment (WEEE). By ensuring that this appliance is disposed of correctly, you will help prevent any possible damage to the environment and to human health, which might otherwise be caused if it were disposed of in the wrong way.

The symbol on the product indicates that it may not be treated as normal household waste. It should be taken to a collection point for recycling of electrical and electronic goods.

This appliance requires specialist waste disposal. For further information regarding the treatment, recovery and recycling of this product please contact your local council, your household waste disposal service, or the shop where you purchased it.

For more detailed information about treatment, recovery and recycling of this product, please contact your local city office, your household waste disposal service or the shop where you purchased the product.

The manufacturer and agent decline all responsibilities in the event of damage caused by improper, incorrect or illogical use of the appliance.

Contact after sales service center when in doubt of the condition of the appliance.

For after sales service [Singapore], please contact

Casa (S) Pte Ltd

15 Kian Teck Crescent, Singapore 628884

Telephone: +65 6268 0077

Fax: +65 6898 0510

Email: service@casa.com.sg