

ELBA

EN Washing Machine / User Manual

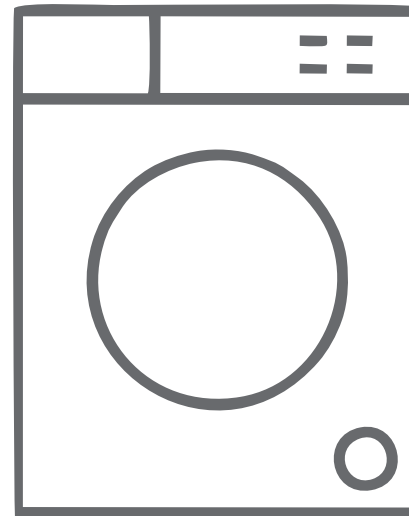

















EWF 70120 WP

CONTENT

IMPORTANT SAFETY INSTRUCTIONS	1-2
PRODUCT OVERVIEW	3
INSTALLATION	4-7
CONTROL PANEL	8
DETERGENT DRAW	8
PREPARATION	9
OPERATION	10
PROGRAM TABLE	11-12
CARE AND MAINTENANCE	15
ERROR CODE	16
TROUBLESHOOTING.....	17-18
TECHNICAL SPECIFICATION	19
WARRANTY & SERVICE	20

IMPORTANT SAFETY INSTRUCTIONS

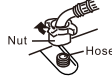
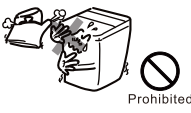



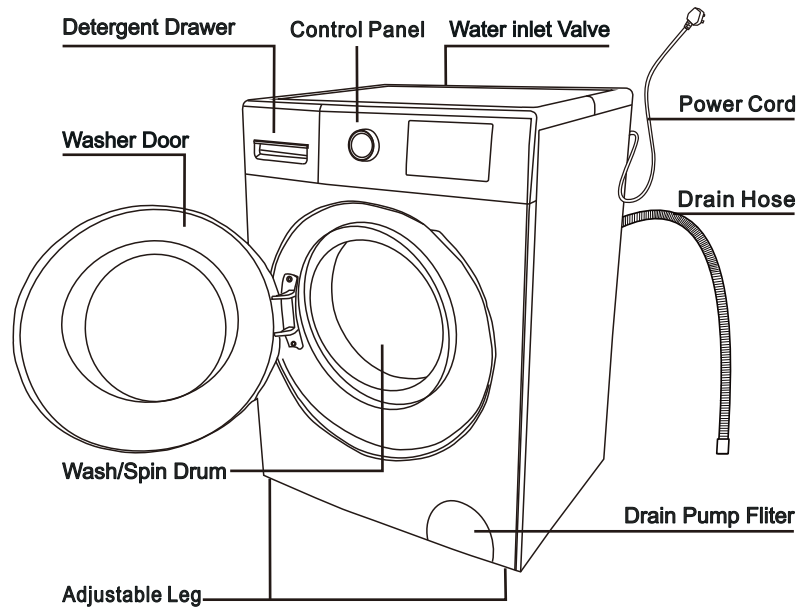

 Warning	
<ul style="list-style-type: none"> ● Dismantle, repair or alterations should only be carried out by professional technicians. This is to avoid electric shock, fire and body injury due to improper activity. 	<ul style="list-style-type: none"> ● Washer is equipped with electricity wire with bioelectrode grounding socket. 
<ul style="list-style-type: none"> ● Electricity supply must be unplugged with dry hands as this will cause electric shock. 	<ul style="list-style-type: none"> ● Do not put water directly on the unit during cleaning or maintenance. This could potentially cause a short circuit on the washer. 
<ul style="list-style-type: none"> ● Damaged plug or loose wiring should not be used. This will cause electric shock, short circuit and fire. ● Do not damaged, alter, bend forcefully, pull or twist and put weight on the wire. ● The wire is there to protect the cables inside. 	<ul style="list-style-type: none"> ● Do not put laundries with stain that consist gasoline, benzine, alcohol, thinner of fabrics into or near the washer as this can cause fire and explosion. 
<ul style="list-style-type: none"> ● Please use the single socket with special voltage and current that match with the plug marked in the specification. Sharing the same socket with other appliances can cause a fire due to overload of power.  <ul style="list-style-type: none"> ● Wipe the plug thoroughly when there is dirt on the prong or around the base of the prong. 	<ul style="list-style-type: none"> ● Keep children away from the washer when it is spinning. This will cause children to fall and be injured. ● Do not place box or shelves on washers as this will cause things to fall and break resulting in injuries. 
<ul style="list-style-type: none"> ● Washer should not be installed at places such as humid, rain or exposed to wind. This can result in electricity shock and fire, thus shortening the structure integrity of the washer. 	<ul style="list-style-type: none"> ● Washer should not be close to locations with candle, mosquito repellent incense or any open flame. ● Do not operate the machine when there is a nearby gas leak. 

<ul style="list-style-type: none"> ● Avoid touching the door of the washer as it gets hot during the process of high-temperature washing. ● If you need to open the door during the high temperature washing program, wait until the temperature inside has lowered with the water being drain out. ● The packing material of the washer can be dangerous such as plastic bag and foam should be kept far away from children. 	<ul style="list-style-type: none"> ● Do not pull the wire from the socket during operation. This could lead to damaging the wire and cause a electric shock.  <ul style="list-style-type: none"> ● Please unplug the washer when it is not being used for a long period of time. 
<ul style="list-style-type: none"> ● Do not place any other foreign object that is not meant to be used in the washer. This will cause the washer to abnormal vibration during spinning and damaged the inside of the washer. 	<ul style="list-style-type: none"> ● Keep hands and feet away from the bottom of the washer during operation. The motion beneath the washer can cause injuries.
<ul style="list-style-type: none"> ● Water supply should be screwed tightly to the washer. After a period of usage, the vibration can cause the nut to be loosen. If this is not check, it could result in water leakage and short-circuit. ● The new hose supplied should be used to replace the old hose. ● Turn off the water tap when washers is not in used. 	<ul style="list-style-type: none"> ● Water above 50degree should not be used when cleaning the body of the washer. The temperature of the hot water can cause a electric shock, deformation of the plastic parts and leakage. 
<ul style="list-style-type: none"> ● This appliance is intended to be used in household. It is not for commercial purposes or it should not be used out of its intended use. 	<ul style="list-style-type: none"> ● The appliance is not to be used by person (including children) with reduced physical, sensory or mental capabilities, or lack of experience and knowledge, unless they have been given supervision or instruction. ● Children being supervised not to play with the appliance.
<ul style="list-style-type: none"> ● This product has been manufactured with high quality parts and materials which can be reused and are suitable for recycling. Do not dispose of the waste product with normal domestic and other wastes at the end of its service life. Take it to the collection center for the recycling of electrical and electronic equipment. 	<ul style="list-style-type: none"> ● Compliance with RoHs Directive: The product you have purchased complies with EU RoHs Directive (2011/65/EU). It does not contain harmful and prohibited materials specified in the directive.
<ul style="list-style-type: none"> ● This appliance is intended to be used in household and similar applications such as: (IEC 60335-2-7) -Staff Kitchen area in shops, offices and other working environments; -Farm Housed; -By clients in hotels, motels and other residential type environments; -Bed and breakfast type environments; -Area for communal use in blocks of flats or in launderettes. 	<ul style="list-style-type: none"> ● -The appliance is not to be used by person (including children) with reduced physical, sensory or mental capabilities, or lack of experience and knowledge, unless they have been given supervision or instruction. -Children being supervised not to play with the appliance. 

PRODUCT OVERVIEW

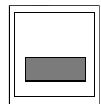

Supplied Accessories

Operation manual 	Water Supply Hose 	Plastic Cover  X 4
Spanner 	Bottom cover 	Screws  X 9

INSTALLATION

Transportation

- During transportation it is recommended that two persons are to carry the machine. Each person on the side carries the machine by holding the machine feet.

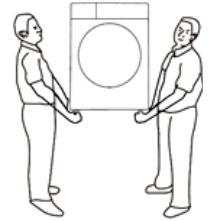

Removing packaging reinforcement

- Remove all packaging around the washer.
- Tilt the machine backwards and remove the bottom Styrofoam packaging and the base protection device.

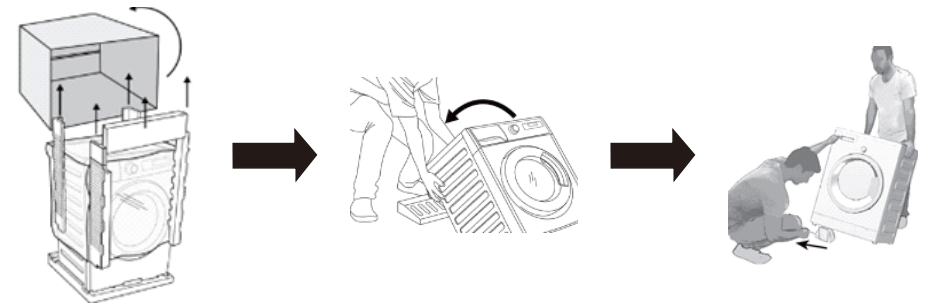

Bottom cover installation

- Use the supplied screws and fix the bottom mount plate as the figure shown below:

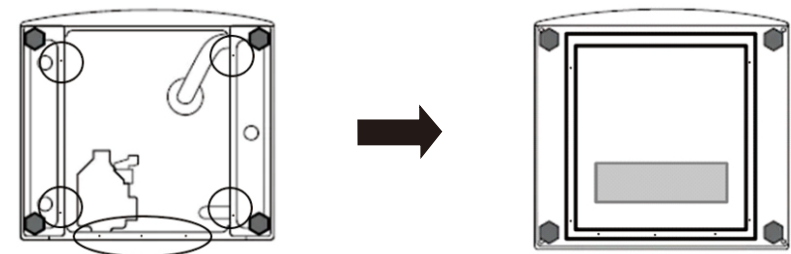

Location of washer

- Washer must remain dry and away from direct sunlight or rain.
- Washer must be placed on a hard, flat and skid proof ground, make sure there is no uneven surface as it will cause the washer rumble or move during operation.



Levelling the washer

- Make sure washer is on a levelled surface.
- To adjust the feet, loosen the lock nuts with the supplied spanner by turning anti-clockwise and adjust all four feet by turning clockwise or counter clockwise with your hand until washer is levelled. Once that is done, use the spanner to tighten the lock nut by turning clockwise.

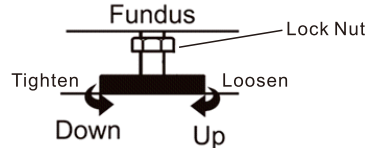

- Check the washer left and right and make sure the washer does not shake. This is to make sure there will be no vibration or sound during operation.

Note:

In order to ensure that the product operates more silently and vibration free, it must stand levelled and balanced on its feet. If this is not done correctly, the washer may move from its place and cause crushing and vibration issue.

Removing transportation bolt

Before operating the washer, remove the 4 transportation bolts from the rear of the washer.

Caution:

The transportation bolts must be removed before operating the washer. Failure to do will result in damaging the washer.

To remove all bolts:

1. Unscrew the 4x bolts that located at the back of the washer using the supplied spanner.
2. Remove bolts by pulling it out.
3. Fit the given plastic cover into the holes.

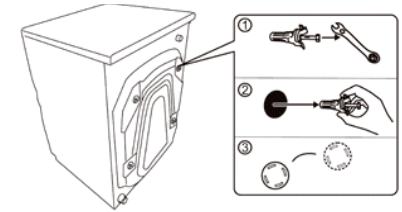

Note:

- This should only be done by trained personnel.
- Keep the transportation bolts for future use.

Connecting the water supply inlet hose

- Connect the inlet hose by tightening the nuts of the hose by hand as the figure below:

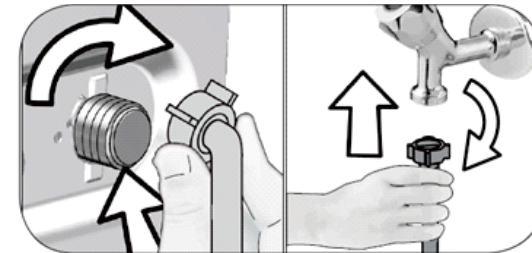

Note:

- Never use a tool when tightening the nuts.
- Once the hose connection is completed, check if there is any leakage at the connection points by opening the taps fully. If there are any leaks occur, turn off the tap and remove the nut. Retighten the nut carefully after checking the seal.

Connecting the drain hose

1. Make sure the water supply is turned off. Remove the drain hose from the drain hose holder.
2. Place the drain hose to the drain pipe or basin as shown in the below figure. **Connect the drain hose to a minimum height of 400mm and a maximum height of 1000mm.**

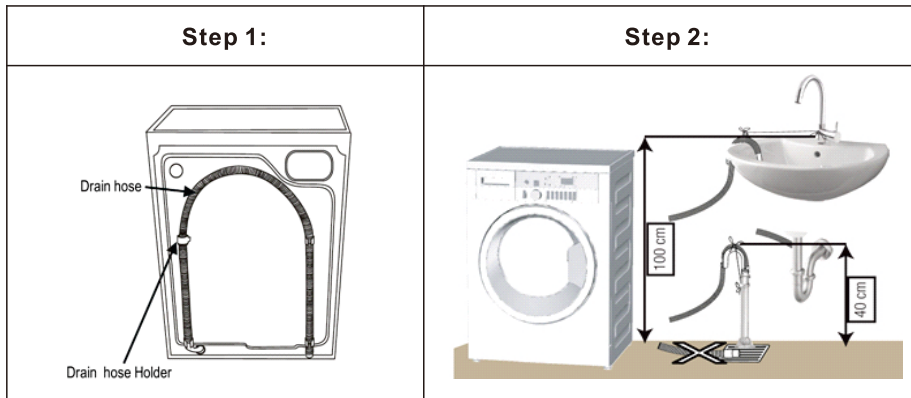

Note:

Your house will be flooded if the hose comes out of its housing during water discharge. Moreover, there is a risk of scalding due to high washing temperatures. In order to prevent such situation, make sure the washer performs water intake and discharge process without any issue and fix the drain hose securely.

Electrical connection

- Connection must comply with national regulations
- The wiring for the electrical outlet circuit must be sufficient to meet the washer requirements.
- The power cable plug must be within easy reach after installation.
- If the current value of the fuse or breaker in the house is less than 16Amps, have a qualified electrician install a 16 Amp fuse.
- The voltage specified in the "Technical specification" section must be equal to your mains voltage.
- Do not make connections via extension cables or multi-plugs.

CONTROL PANEL

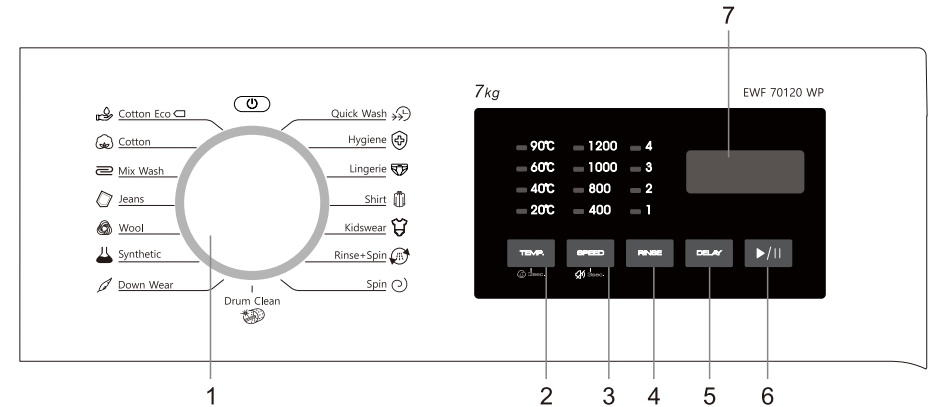

1. Program Selection Knob and On/Off
2. Temperature Adjustment Button (Child Lock)
3. Speed Adjustment Button (End Buzzer)
4. Rinse Adjustment Button
5. Delay End Button
6. Start / Pause Button
7. Display Screen

DETERGENT DRAWER

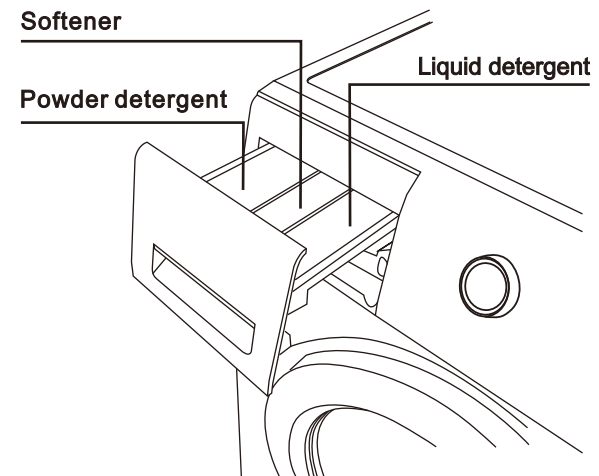

PREPARATION

Sort the laundry

- Care label: Sort your laundry from cottons, mixed fibres, synthetics, silks, wools and rayon. Always obey the instructions given on the laundry tags.
- Colour: Separate white from colours.
- Size: Washing performance can be affected by the size of items being washed together.
- Sensitive: like lingerie, lace and silk require a gentler wash with a reduced spin speed and low temperature.

Prepare the laundry

- Metal objects such as key, coins, pin and belt buckles on the garments can potentially damage the other laundry when mixed or worse the drum itself.
- It is a good practice to flip inside out of the laundry with buttons and zippers as it will damage the drum and other laundry.
- Shirt that has iron prints should also be flipped inside out as it will add a layer of protection and prevent other laundry in the same load rubbing against the print.
- Laundry with long string should be tied down or flip inside out before washing as it can cause entangled with other laundry.

Use laundry net

- Small clothing like socks, gloves, stocking and handkerchiefs may get caught in the door gasket sometimes. It is recommended that all these should be placed into a fine laundry net.

Determine the laundry capacity

- Do not overload the washer as this will affect the performance of the washing and the life span of the washer.
- Unbalanced laundry can cause vibrations strong enough to move the washer, which can lead to a costly repair
- Make sure all laundry is fully inserted into the drum so that it does not get caught in the door and damaged your laundry.

Use the correct detergent

- Ensure to adhere to the detergent manufacturer's recommended amount base on the load of the laundry.
- Use the correct detergent that is designed for front load washer.
- Never use detergent that have the tendencies to harden or solidified. This will cause the remains to block the drain outlet after rinse.
- If you are using capsules, remember to place the capsules at the bottom of the clothes.

OPERATION

Initial use

- Perform first operation in “Drum Clean” program before washing laundry.
 1. Make sure that all the hose are connected tightly.
 2. Turn on power and water tap.
 3. Add detergent in the washer.
 4. Perform the first operation by turning the program selection knob to “Drum Clean” and press start.
 5. After the program is completed, wipe the inside of drum with a clean cloth.
 6. Leave the door open to let it air dry.

Note: Some water might have remained in the drum due to quality inspection process in the production. It is normal and is not harmful for the product.

Program selection

- After you have followed the “Initial use” guideline, use the programme selection knob to select the programme suitable for the type, quantity and level of soil of the laundry in accordance with the program table.
- Follow the flow chart on how to tune to your washing preference.



LOAD: Load your laundry into the washer.

PROGRAM: Select the appropriate program that you require for your laundry, using the program selection knob.

ADJUST: Each program comes with default temperature, spin speed and number of rinses. If you need to adjust these functions, you can do so by pressing the adjustment button respectively.

WASH: Once all is done press the Start/Pause button to start washing.

Note: The washer will automatically switch into energy saving mode and power off after 10 minutes if the washer is idle without any activities.

PROGRAM TABLE

Program	Max load (KG)	Temperature (°C)	Spin Speed (RPM)	No. of rinse	Duration	Program description
Cotton Eco**	7	40*	1000* (400-1200)	2*(0-4)	1.17hrs	Use to wash your normally soiled, durable cotton and linen laundry. Water consumption will decrease more, providing a more economic wash.
Cotton	7	40* (cold-20-40-60-90)	1000* (400-1200)	2*(0-4)	2.28hrs	Use to wash heavily soiled, durable cotton.
Mix Wash	6	40* (cold-20-40-60)	1000* (400-1000)	2*(0-4)	1.18hrs	Mixed load consisting of textiles made of cotton and synthetics.
Jeans	5	40* (cold-20-40)	1000* (400-1000)	2*(0-4)	1.18hrs	Use to wash black and dark coloured cotton or jeans. Do not wash your delicate clothes that contain wool etc. in this program.
Wool	2	0* (cold-20-40)	800* (400-800)	2*(0-4)	1.05hrs	Hand or machine-washable wool or rich wool textiles. Especially gentle wash programme to prevent shrinkage.
Synthetic	6	40* (cold-20-40)	800* (400-1000)	2*(0-4)	1.28hrs	Designed for non-cotton clothing that needs a slightly more delicate wash.
Down Wear	2	40* (cold-20-40)	800* (400-1000)	3*(0-4)	1.31hrs	Use to wash for any machine washable clothes containing feathers; with the special spinning profiles in this programme, it ensures that water reaches all the air gaps in feathers.
Quick Wash	1	cold* (cold-20-40)	800* (400-1000)	1*(0-4)	0.16hrs	Use this program for lightly soiled cotton in a shorter time with small amount of laundry.
Hygiene	4	60* (60-90)	800* (400-1200)	3*	2.03hrs	This wash program is commonly used for heat resistant fabrics such as cotton. The high temperatures will help to kill most of the germs or bacteria on your clothes and the temperatures can go up to 90°C.
Lingerie	3	40* (cold-20-40-60)	800* (400-1000)	3*(0-4)	1.31hrs	Design to wash delicate garments that are suitable for handwash and delicate underwear / lingerie. Small number of garments must be washed in laundry net.

Program	Max load (KG)	Temperature (°C)	Spin Speed (RPM)	No. of rinse	Duration	Program description
Shirt	3	40* (cold-20-40-60)	800* (400-1000)	2*(0-4)	1.15hrs	Use to wash the shirts made from cotton, synthetic and synthetic blended fabrics altogether. It reduces wrinkles.
Kidswear	4	40* (cold-20-40-60)	800* (400-1200)	3*(0-4)	1.43hrs	A special wash cycle designed for children laundry and towels, cycle completes in less than two hours and tends to wash at higher temperatures to kill off bacteria with additional rinse.
Rinse+Spin	7	-	1000* (400-1200)	1*(0-4)	0.21hrs	To rinse laundry separately.
Spin+Drain	7	-	1000* (400-1200)	-	0.12hrs	Use to remove the water on the clothes in the machine.
Drum Clean	-	90*	800	1*	2.19hrs	A self-cleaning cycle called Drum Clean* which heats up water up to 90°C to remove any bacteria or build-up from the drum of your washing machine. This can also remove any dirt that has accumulated in the rubber door gasket.

Note:

- “ * ” is the default settings.
- The program “ Cotton Eco** ” is the recommended program designed to minimize water consumption for normally soiled cotton laundry.
- Water and power consumption may vary subject to the changes in water pressure, water hardness and water temperature, ambient temperature, the type and amount of laundry and changes in the main voltage.
- When selecting a program, you can see the washing duration on display of your machine. Depending on the amount of laundry you have loaded into the washer., there might be a difference of 1-1.5hours between the duration shown on the display and the actual duration of the washing program. The duration will be corrected automatically right before the start of the program.

Delay End

Delay end function allows you to set the washing end time up to 24hours. You can set the delay time by 1 hour interval.



To activate the function:

- 1.Select the washing program, if required set the temperature, spin speed and the number of rinses.
- 2.Press “Delay” button and set the desired end time.
- 3.Press the Start/Pause button. The delayed end time you have set will be displayed. Countdown will start for delay end. The icon “  ” and the selected time will be shown on the display.
- 4.As the countdown time has come to an end, washer will display the selected program duration and start washing.

Changing or cancel the delay end time:

To cancel, you can turn the selection knob to the off position and program will be reset. If you need change the time, you can repeat the same step to set the function again.

Note:

- After the Delay End Function program has been selected, the door will be locked and adding/removing laundry is not allowed.

Adding or removing laundry

- 1.Press the Start/Pause button, to pause the washer.
- 2.Wait until the washer door can be opened when the lock icon “  ” has disappeared.
- 3.Open the washer door to add or take out the laundry.
- 4.Close the door.
- 5.Press the Start/Pause button to start the washer.

Note:

- If the lock icon “  ” is not disappearing after you have pressed the start/pause button, this means that water level is too high and adding or removing laundry is not allowed.
- Do not forcefully open the door as this will cause the door or lock to be damaged.

Child Lock

Child lock function is to prevent children from tampering with the washer. While the child lock is activated, you cannot make any change in the program and all buttons are locked except on/off button.

Note: Child Lock is activated only during the washing operation.

- **To activate child lock**, Press and hold “Temperature Adjustment” Button for 3 seconds until the child lock indicator light is on.
- **To deactivate child lock**, Press and hold “Temperature Adjustment” Button for 3 seconds until the child lock indicator light is OFF.

End Buzzer

Upon completion of each program, there will be acoustic signal indicating the program is completed. You may deactivate the acoustic signal (End Buzzer).



- **To Deactivate Buzzer after washer operation is completed:**
Press and hold the speed adjustment button for 3 seconds until you hear a “beep” sound.
- **To reactivate Buzzer after washer operation is completed:**
Press and hold the speed adjustment button for 3 seconds until you hear a “beep” sound.

CARE AND MAINTAINENCE

Drum Clean

It is always a good practice to perform drum clean once a month to remove any bacteria or build-up from the drum of your washer.

Follow the table below to clean the washer

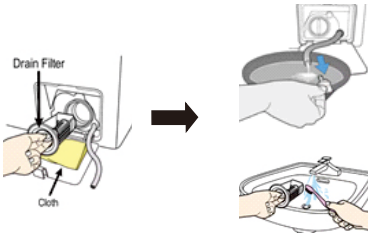
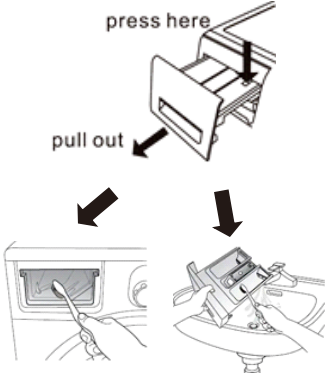
Cleaning the washer body	Cleaning the water inlet valve
<p>Use a soft clothing to wipe off any water or dirt on the surface.</p> <ul style="list-style-type: none"> Do not spray water directly on the washer body. To avoid damaging the surface, do not use detergent, propellant and other concentrated chemicals. 	<p>After long time use, the water inlet mesh may be blocked by collected dirt or debris.</p> <ul style="list-style-type: none"> To clean the mesh filter, turn off the power and the water supply. Take out the water inlet hose, then take out the mesh filter and start removing away the debris with a small tooth brush. Once done, you can install everything back and start washing again. 
Cleaning drain pump filter	Cleaning detergent drawer
<p>Running your washer with a clogged drain filter can limit your washer's efficiency and can also lead to poor drainage. This will cause lint desposits on laundry and bad odor from the unwanted detergent residue that is left behind.</p> <ol style="list-style-type: none"> Turn of the washer power and water supply. Locate the filter at the bottom right of the washer. Take out the emergency filter tube, and pull out the plug then drain out the dirty water. Open the cover and pull out the filter by turning counter-clockwise until the filter is out completely. It is advisable to put a cloth under the filter as water will leak out while taking out the filter. Take the filter out and start removing the collected debris and brush it with a small tooth brush. Once done the filter is free from dirt and residue you can install it back. 	<p>Cleaning the drawer will keep the washer efficient and hygienic.</p> <ul style="list-style-type: none"> Open the detergent drawer and press down the nub on the right of the compartment then pull it out. Take a tooth brush and start cleaning around the detergent drawer and the drawer recess. After wash, you can install everything back and start washing again. 

ERROR CODE

If your washer is experience problems, it will show a code on display. Each code indicates the different types of issue your washer is facing. Use the table below to identify the cause of your error with any possible solutions.

Error Code	Problem	Solution
No display	Out of operation	Refer to page 16, No. 1
E11	No water	Refer to page 16, No. 4
E12	Water not drained	Refer to page 16, No. 5
H	Door can't be opened	Refer to page 16, No. 2
U3	No spin	<ul style="list-style-type: none"> Make sure you have loaded the correct capacity according to the user manual. Due to the overloaded of laundry, washer is unable to spin. Too little amount of laundry being loaded. Try adding more pieces of cloth and press "Start/ Pause" again.
U4	Door not closed	<ul style="list-style-type: none"> Check to make sure the laundry that is properly placed inside the drum and not causing any issue when closing the door.
Other error codes	Alarm	<ul style="list-style-type: none"> Turn the control programmable control knob on/Off and restart again. If all fails, please contact customer service centre.

Note:

Please do not disassemble the unit by yourself to avoid any dangers and damages to the washer. If you cannot remove the fault codes and the washer needs to be repaired, please contact the customer service.

TROUBLESHOOTING

Try the suggestion below before calling the customer service centre. Before you proceed the following steps, please make sure to do the following below:

- Unplug your washer
- Turn the water supply off

Problem	Causes	Troubleshooting
Your machine does not start or no display.	It is not plugged in.	Plug it.
	Fuse blown.	Replace the fuses.
	Electricity Cut off.	Check main power.
	Washer door is not completely closed.	Close the door properly.
Door cannot be opened	The water level is too high	Drain the water fully by using "Spin" program and wait for a while, the door should be able to unlock automatically once the water is drained out.
	The laundry is clamped between the door and gasket.	Open the drain pump cover, locate a white string and pull the it down to manually unlock the door for emergency purpose. (Make sure the washer is not in operation and water is fully drained out before pulling the string)
Peculiar smell	Door gasket contains rubber material.	After multiple wash, smell will go away.
Washer does not intake water	Water tap is turned off.	Turn the tap on.
	Water inlet hose may be twisted.	Check water inlet hose and untwist.
	Water inlet hose clogged.	Clean water inlet hose filters.
	The door is not completely closed.	Close the door fully.
Washer does not discharge water	Drain hose has been clogged or twisted.	Check the drain hose, then either clean or untwist.
	Check the drain hose, then either clean or untwist.	Clean the drain pump filter.
Washer vibrates and knocking sound	The washer is not levelled.	Adjust the feet of the washer.
	Transportation bolt has not been removed.	Remove transportation bolt.
	Unbalance load of laundry in the washer.	Make sure all laundry is not in one laundry net. Spread out the laundry or add more laundry.
	Washer is overloaded.	Use the correct max capacity for the washer.
	Hairpin, coins or other foreign objects fall in the drum.	Remove all foreign objects before wash.

Problem	Causes	Troubleshooting
Excessive foam formed in the detergent drawer	Excessive amount of detergent is used.	Pour a cup of water and softener down into the liquid detergent compartment and let the washer continue, after rinse and spin cycle the foam will be eliminated.
	Wrong detergent used.	User detergents only meant for front load washing machine. (Low sud)
Unsatisfactory of washing result	The level of soil of your laundries does not match with the program you have chosen.	Select the program appropriate to the level of soil of your laundries.
	Amount of detergent used is insufficient.	Adjust the amount of detergent base on the level of soil of your laundries.
	Laundry in your washer is over the maximum capacity.	Load your washer with the correct amount of capacity without exceeding the maximum.
As soon as the washer is loaded with water, water is drain out	The end of the drain hose is too low for the machine.	Set the drain hose height at suitable height between 400 to 1200mm.
Laundry has detergent residues on them	Non-dissolving particles of some detergent may stick to your laundries as white spot.	Perform an extra rinsing by setting the washer to "Rinse and Spin" program.
Grey spots appeared on the laundry	The reason for such spot may be oil, cream or ointment.	Apply the recommended amount of detergent as instructed on the packaging in the next washing operation.

TECHNICAL SPECIFICATION

Model:	EWF 70120 WP
Capacity:	7kg
Dimensions (mm):	600(W) x 580(D) x 850(H)
Net Weight:	63kg
Input Voltage & Frequency:	230-240/50Hz
Rated power:	1800W
Required Water Pressure:	0.03~1.0MPa

WARRANTY & SERVICE

- To activate your warranty, please register your appliance.
- Warranty registration can be done via our website or scan the QR code below

Website

<https://shop.casa.sg/E-Warranty>

QR Code

Scan the QR Code below. It will redirect straight to our “Warranty Registration” page.



Casa (S) Pte Ltd. reserves the rights to the final interpretation of the content of this manual. Customer will not be notified in the event of any amendments to the content.

The manufacturer and agent decline all responsibilities in the event of damage caused by improper, incorrect or illogical use of the appliance.

Contact customer care center when in doubt of the condition of the appliance. Please get ready the model number of your appliance, date of purchase and the product issue when contacting customer care center.

For customer care / after sales service [Singapore], please contact

Casa (S) Pte Ltd
15, Kian Teck Crescent, Singapore 628884
Whatsapp: +65 9747 8743
Fax: +65 6898 0510
Email: service@casa.com.sg