

**Multifunction Oven**

**BO-AE 62-A**  
**BO-AE 85-A**



THE BEAUTY OF SIMPLICITY



USER MANUAL



# Instructions for installation and use

We recommend that you read the instructions in this owner's manual carefully before use for the best performance and to extend the life of your appliance, as it will provide you with all the instructions you require to ensure its safe installation, use and maintenance. Always keep this owner's manual close to hand since you may need to refer to it in the future. Thank you.

## Close-up view

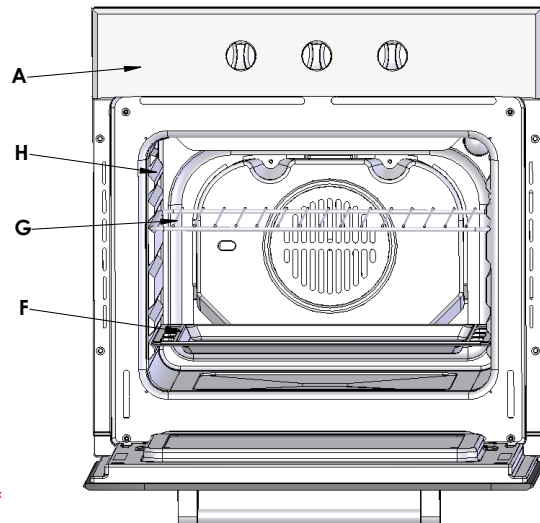
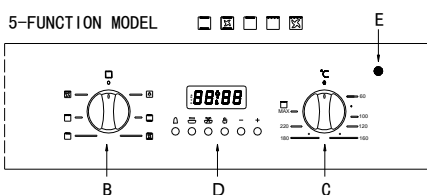
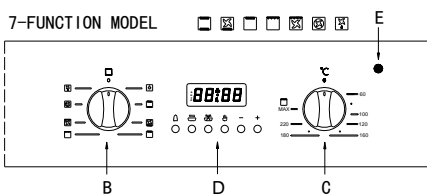
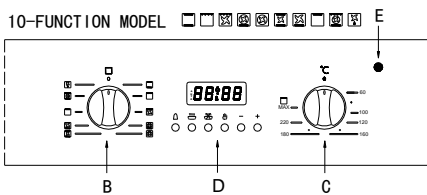
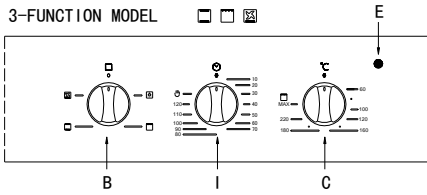
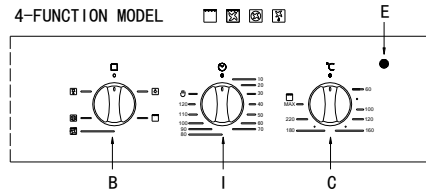
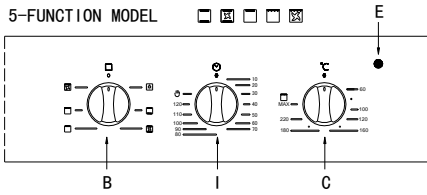
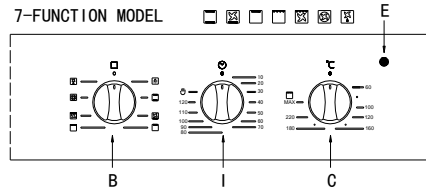
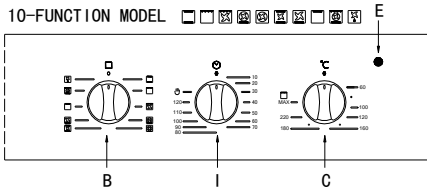

CONTROL PANEL FOR SWITCH BUTTON (mechanical timer)

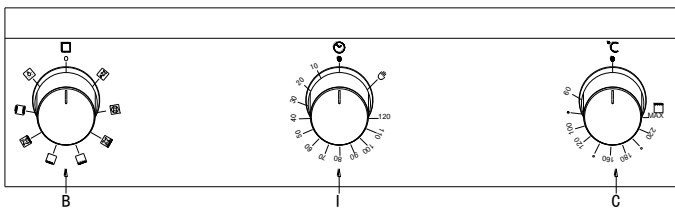

CONTROL PANEL FOR SWITCH BUTTON (electrical timer)

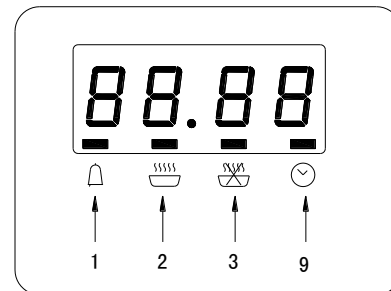
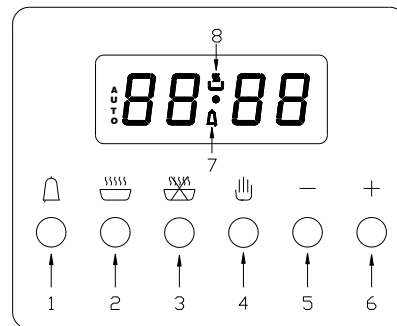
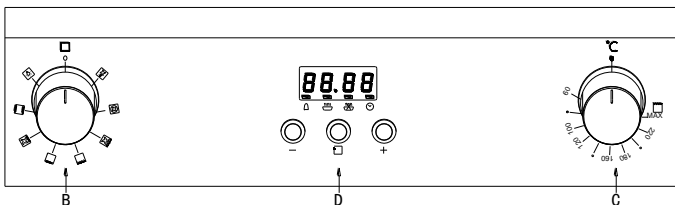

- A. Control Panel
  - B. Cooking mode selection knob
  - C. Cooking temperature selection knob
  - D. **Electronic programmer**-Allows you to programme the desired cooking by selecting the cooking time and the end cooking time. It can also be used as a timer (only available on certain models)
  - E. **Oven indication light** (only available on certain models)  
-When lit, it indicates the ovens is heating up to the temperature set
  - F. **Dripping Pan or Baking Sheet**
  - G. **Oven Rack**
  - H. **Guides for sliding the racks or dripping in and out**
  - I. **End Cooking Time Knob**
- |                                    |                                    |
|------------------------------------|------------------------------------|
| 1. <b>Timer</b>                    | 4. <b>Manual operation setting</b> |
| 2. <b>Cooking time setting</b>     | 5. <b>Carrying forward button</b>  |
| 3. <b>End cooking time setting</b> | 6. <b>Carrying backward button</b> |
|                                    | 7. <b>Timer indicator</b>          |
|                                    | 8. <b>Cook indicator</b>           |
|                                    | 9. <b>Clock</b>                    |

## How to use your oven

This multi-function oven combines the advantages of traditional convection ovens with those of the more modern fan assisted models in a single appliance.

It is an extremely versatile appliance that allows you to choose easily and safely between different cooking modes. The various features offered by the oven are selected by means of selector knob “B” and thermostat “C” situated on the control panel.

**Push-in control knob** (only available on certain models)

Control knob can be pushed in, and you can push the control knob lightly to release it or lock it.

**Notice:** The first time you use your appliance, we recommend that set the thermostat to the highest setting and leave the oven on for about half an hour with nothing in it, with the oven door shut. Then, open the oven door and let the room air in. The odor that is often detected during this initial use is due to the evaporation of substances used to protect the oven during storage and until it is installed.

**Notice:** Place the dripping pan provided on the bottom shelf of the oven to prevent any sauce and/or grease from dripping onto the bottom of the oven only when grilling food or when using the rotisserie (only available on certain models). For all other types of cooking, never use the bottom shelf and never place anything on the bottom of the oven when it is in operation because this could damage the enamel. Place your cookware (dishes, aluminum foil, etc. etc.) On the grid provided with the appliance inserted especially along the oven guides.

**Notice:** to use the oven in manual mode (not using the end cooking time programmer); the  symbol must be aligned with the reference mark on the control panel.

### Convection mode 2100-2520W

Position of thermostat knob “C” :between 60°C and Max. on this setting ,The top and bottom heating elements come on .This is the classic ,traditional type of oven which has been perfected ,with heat distribution and reduced energy consumption .The convection oven is still unequalled when it comes to cooking dishes made up of ingredients ,e. g. cabbage with ribs ,Spanish style cod ,Ancona style stockfish ,tender veal strips with rice ,etc .Excellent results are achieved when preparing veal or beef-based dishes as well (braised meats ,stew ,goulash, wild game ,ham etc. )which need to cook slowly and basting or the addition of liquid .It remains the best system for baking cakes as well as fruit and cooking using covered casserole dishes for oven baking .When cooking in convection mode ,only use one dripping pan or cooking rack at a time ,otherwise the heat distribution will be uneven .Using the different rack heights available, you can balance the amount of heat between the top and the bottom of the oven .Select from among the various rack heights based on whether the dish needs more or less heat from the top .

### “Fast cooking” Mode 2125-2560W

Position of thermostat knob “C” :Between 60°C and Max. The top and bottom heating elements, as well as the fan ,will come on ,guaranteeing constant heat distributed uniformly throughout the oven.

This mode is especially recommended for cooking pre-packed food quickly (as pre-heating is not necessary), such as for example: frozen or pre-cooked food) as well as for a few “home-made” dishes.

The best results when cooking using the “Fast cooking” mode are obtained if you use one cooking only (the second from the bottom), please see the table entitled “Practical Cooking Advice” .

### Multi-Cooking Mode 2370-2924W

Position of thermostat knob “C”: Between 60°C and Max. The top circle and bottom heating elements, as well as the fan, will come on alternately. Since the heat remains constant and uniform throughout the oven, the air cooks and browns food uniformly over its entire surface. With this mode, you can also cook various dishes at the same time, as long as their respective cooking temperatures are the same. A maximum of 2 racks can be used at the same time, following the instructions in the section entitled: “Cooking On More Than One Rack”.

This cooking mode is particularly recommended for dishes requiring a gratin finish or for those requiring considerably prolonged cooking times, such as for example: lasagna, pasta bakes, roast chicken and potatoes, etc.. Moreover the excellent heat distribution makes it possible to use lower temperatures when cooking roasts. This results in less loss of juices, meat which is more tender and a decrease in the loss of weight for the roast. The Multi-cooking mode is especially suited for cooking fish, which can be prepared with the addition of a limited amount of condiments, thus maintaining their flavor and appearance. Excellent results can be obtained when cooking vegetable-based side dishes like courgettes, aubergines, peppers, etc...

Desserts: this mode is also perfect for baking leavened cakes.

This mode can also be used to thaw quickly white or red meat and bread by setting the temperature to 80°C. To thaw more delicate foods, set the thermostat to 60°C or use only the cold air circulation feature by setting the thermostat to 0°C.

### **Pizza Mode** 2772-3420W

Position of thermostat knob “C”: Between 60°C and 250°C. The bottom and circle heating elements, as well as the fan, will come on. This combination rapidly heats the oven due to the large amounts of power used by the appliance, which results in the production of considerable heat coming prevalently from the bottom.

The pizza mode is ideal for foods requiring high temperatures to cook, like pizzas and large roasts. Only use one oven tray or rack at a time. However, if more than one is used, these must be switched halfway through the cooking process.

### **Delicate cooking** 1220-1460W

Position of thermostat knob “C”: Between 60°C and 250°C. The bottom heating element and the fan come on. Suitable for pastries, cakes and non-dry sweets in baking tins or moulds. Excellent results are also obtained in cooking requiring above all heat from the bottom.

You are advised to put the pan on a low level.

### **“Top”oven** 940-1110W

Position of thermostat knob “C”: Between 60°C and Max. The top heating element comes on. This mode can be used to brown food at the end of cooking.

### **Grill** 2090-2520W

Position of thermostat knob “C”: Max. The top central heating elements come on. The extremely high and direct temperature of the grill makes it possible to brown the surface of meats and roasts while locking the juices in to keep them tender. The grill is also highly recommended for dishes that require a high temperature on the surface: beef steaks, veal, rib steak, filets, hamburgers etc ...

**Cook food with the oven door ajar.**

Some grilling examples are included in the “Practical Cooking Advice” paragraph.

### **Fan Assisted Grill** 2100-2550W

Position of thermostat knob “C”: Between 60°C and 200°C. The top central heating elements and the fan come on. This combination of features increases the effectiveness of the unidirectional thermal radiation of the heating elements through forced circulation of the air throughout the oven. This helps prevent food from burning on the surface, allowing the heat to penetrate right into the food. Excellent results are achieved with kebabs made with meats and vegetables, sausages, ribs lamb chops, chicken in a spicy sauce, quail, pork chops, etc.

**Cook food in “fan assisted grill mode” with the oven door shut.**

This mode is also ideal for cooking fish steaks, like swordfish, stuffed cuttlefish etc.

### **Baking Mode** 1660-2020W

Position of thermostat knob “C”: Between 60°C and 250°C. The rear heating element and the fan come on, guaranteeing delicate heat distributed uniformly throughout the oven.

This mode is ideal for baking and cooking delicate foods—especially cakes that need to rise, and for the

preparation of certain tartlets on 3 shelves at the same time. Here are a few examples: cream puffs, sweet and savory biscuits, savoury puffs, Swiss rolls and small portions of vegetables au gratin, etc. ...





**“Defrosting” Mode**  45-55W

Position of thermostat knob **“C”** :Any

The fan located on the bottom of the oven makes the air circulate at room temperature around the food .This is recommended for the defrosting of all types of food ,but in particular for delicate types of food which do not require heat ,such as for example :ice cream cakes ,cream or custard desserts ,fruit cakes .By using the fan ,the defrosting time is approximately halved .In the case of meat ,fish and bread ,it is possible to accelerate the process using the **“Baking”** mode and setting the temperature to 80°C-100°C .

**The turnspit** (only available on certain models)

To start the turnspit, proceed as follows:

- place the oven tray on the 1st rack ;
- insert the special turnspit support on the 2nd rack and position the spit by inserting it through the special hole into the turnspit at the back of the oven ;
- start the turnspit using knob **“B”** to select setting / / / / .

**End Cooking Time Knob (I)** (only available on certain models)

This model is equipped with a timer to control when the oven shuts off during cooking. Position of timer knob **“I”** :Between **10minutes** and **120 minutes**.

At the end of the programmed length of time, the timer will sound and automatically turn off the oven.

**6-keys timer procedure baking mode** (only available on certain models)

**Digital clock**



- Showing time:(0:00-24:00) and minutes.
- The screen shows 3 glittery number and **“AUTO”** if the power is on.
- In order to set the correct time, press the  button first, then + or - button to carry forward or backward the figure until the exact time shows.

**Manual operation setting**

Press the  button to remove the flashing of **“AUTO”** .

If **“AUTO”** is flashing (automatic or semi automatic program has been set),press  button to remove **“AUTO”** and then the manual operation process is on.

**Automatic setting (set the time of full automatic starting and ending)**

- 1.Press  button, set roast time;
- 2.Press  button, set roast finish time;
- 3.Set temperatures and roast modes by turning the thermostat knob and selector knob.

After the above setting, **“AUTO”** will be glittering, which means the roast process of the oven is set.

**For example:** if roast time takes 45 minutes and expect it will end at 14:00.

Press,  the roast time is to be 45 minutes;

Press,  the roast is set to end at 14:00.

After the above setting, the screen shows the real time(hour、 minute)and flashing **“AUTO”** ,it means the set roast process is memorized automatically.

When the clock turns to be 13:15(or between 13:14-13:15), the oven will start automatically.



In the roast time,  and **“AUTO”** will be always flashing.

When the clock turns to be 14, the roast has been finished automatically. The alarm will ring and **“AUTO”** will flash, press the  button and the ringing will stop.

**Semi-automatic setting (set the time of automatic starting and ending)**



A. Set the time limit of roast (10 hours maximum):

Press the  button to set the time of roast;

The oven starts immediately,  and **“AUTO”** will flash. After the roast is finished, the roast operation process will be shut automatically. Then **“AUTO”** flashes, the alarm rings. The ringing will stop after the  button is pressed.

B. Set the time of ending (23 hours 59 minutes maximum):

Press the  button to set the time of ending;





The oven starts immediately,  and **“AUTO”** will flash. When the set time of ending is reached, the roast process will shut automatically. Then **“AUTO”** flashes, the alarm rings. The ringing will stop after the  button is Pressed.

When the related button is pressed, the set roast process will be displayed. Whenever the  button is pressed,

and set backward the time to “0”, the set roast process will be cancelled. When  button is pressed again, the oven will revert to the manual operation process.

### Timer

23 hours 59 minutes can be set as maximum.

To set the time, press the  button, and then + or - button, until the required time is shown on the screen. After the setting, the correct time (hour, minute) and the  button will show on the screen. When the  button is pressed the time displaced will be seen. When the set time is reached,  disappears and the alarm will ring again. To stop the alarm, press the  button.

**Notice:** After pressing the related button, setting is supposed to be done in 5 seconds. In case of blackout, the set process as well as the real time (hour, minute) will disappear. After the power is on again, three “0” and “AUTO” shows on the screen, the oven will automatically reset.

**3-keys timer procedure baking mode** (only available on certain models)

### Adjust the clock after switch on:



Once it connected with electrical power, the display will show “12:00” with the square symbol above  ; Press the “+” or “-” button will increase or decrease the number until it reaches the right time; after 5 seconds it will start automatically or you can press the function button to make it work.

### Automatic setting (set the time of full automatic starting and ending)

1. Press the function button repeatedly until the square symbol above the  flashes, and press “+” or “-” button to set the time frame baking for;

2. Press the function button repeatedly until the square symbol above the  flashes, and press “+” or “-” button to set the time to switch off;

3. Adjusting the constant temperature button and choosing button to set temperature and baking method.

After these setting, the symbols above the  and  will flash, it indicates the baking procedure of oven has been set.

For example: if the food is required to bake for 45 minutes, and it is supposed to stop at 14:00.

Press the function button repeatedly until the square symbol above  flashes, and set the time of baking to 45 minutes;

Press the function button repeatedly until the square symbol above  flashed, and set the end time of baking at 14:00.

After these setting, the proper clock (hour, minute) and the square symbol will show on the display, it indicates the setting of baking procedure has been remembered automatically.

When the clock shows at 13:15 (between 14 -15min), the oven will switch on automatically.



During the baking time frame, the square symbol will keep flashing.

When the clock shows 14:00, baking will switch off automatically. The alarm will ring, the square symbol will flash, To stop the ringing press any button.

### Semi-automatic setting (set the time of automatic starting and ending)



A. setting the time frame of baking (10 hours longest)

Press the function button repeatedly until the square symbol above  , and set the time frame of baking;

Switch on the oven immediately, the square symbol above  begins to flash. When the baking is done the square symbol above  will flash, and alarm ring, To stop the ringing press any button.



B. setting the end time off baking (23hours and 59minutes longest)

Press the function button repeatedly until the square symbol above  flashes, and set the end time of baking;

Switch on the oven immediately, the square symbol above  begins to flash. When it reaches the time set, baking procedure will switch off automatically. The square symbol above  flashes, the alarm will ring, the square symbol will flash. To stop the ringing press any button.

The set baking procedure could be seen by pressing any function button repeatedly at any time, only if the time frame of baking is at “0” position. By adjusting the end time of baking to the current time, the set baking procedure can be cancelled.

### Timer

The longest time frame can be set is 23 hours and 59 minutes. For setting time, press the function button repeatedly until the square symbol above  flashes, and press “+” or “-” button until the time supposed shows on the display. After setting, the proper time (hour, minute) and the square symbol above the  begins to flash. In addition, the time countdown begins to work. When it reaches the set time, the square symbol above the  flashes, and the alarm will ring, the square symbol will flash, To stop the ringing press any

button.

**Notice:** press the relevant button, the setting must be carried out in 5 seconds; if electricity failure suddenly, all the set procedure and the proper clock time (hour, minute) will disappear.

After electrical power is on again, “12:00” and the square symbol above “☺” will show on the display, you need to set it again .

### The oven light

Set knob “B” to the  symbol to turn it on .It lights the oven and stays on when any of the electrical heating elements in the oven come on.

### Cooling ventilation

In order to cool down the exterior of the appliance, this model is equipped with a cooling fan, which comes on automatically when the oven is hot.

When the fan is on, a normal flow of air can be heard exiting between the oven door and the control panel.

**Note: When cooking is done, the fan stays on until the oven cools down sufficiently.**

## How to Keep Your Oven in Shape

Before cleaning your oven, or performing maintenance, disconnect it from the power supply.

**To extend the life of your oven, it must be cleaned frequently, keeping in mind that:**

- the enameled or stainless steel parts should be washed with lukewarm water without using any abrasive powders or corrosive substances which could ruin them ;Stainless steel could get stained .If these stains are difficult to remove, use special products available on the market. After cleaning, it is advisable to rinse thoroughly and dry.

- the inside of the oven should preferably be cleaned immediately after use ,when it is still warm ,with hot water and soap ;The soap should be rinsed away and the interior dried thoroughly. Avoid using abrasive detergents (for example cleaning powders, etc) and abrasive sponges for dishes or acids (such as lime scale –remover, etc···) as these could damage the enamel .If the grease spots and dirt are particularly tough to remove, use a special product for oven cleaning, following the instructions provided on the packet. Never use a steam cleaner for cleaning inside of oven.

- if you use your oven for an extended period of time ,condensation may form .Dry it using a soft cloth.

- there is a rubber seal surrounding the oven opening which guarantees its perfect functioning .Check the condition of this seal on a regular basis .If necessary, clean it and avoid using abrasive products or objects to do so. Should it become damaged, please contacts you're nearest After-sales Service Center .We recommend you avoid using the oven until it has been repaired.

- never line the oven bottom with aluminum foil ,as the consequent accumulation of heat could compromise the cooking and even damage the enamel .

- clean the glass door using non-abrasive products or sponges and dry it with a soft cloth .

### How to Remove the Oven door

For a more thorough clean, you can remove the oven door. Choose the remove and assemble method

According to different structure of oven door purchased. Proceed as follows:

Oven door structures 1 remove and assemble procedure:

- Open the door fully ;
- Lift up and turn the small levers situated on the two hinges ;
- Grip the door on the two external sides ,shut it slowly but not

Completely;

- Pull the door towards you ,pulling it out of its seat ;

Reassemble the door by following the above procedures backwards.

Oven door structures 2 remove and assemble procedure:

- Open the door fully ;
- lift up and turn the small levers located on the two hinges ;
- Grip the door on the two external sides and close it approximately half

Way. Unlock the door by pressing on the clamps **F**,and then pull the door towards you lifting it out of its seat. To replace the door, reverse this sequence.

### Replacing the Oven Lamp

- Disconnect the oven from the power supply by means of the omni polar switch used to connect the appliance to the electrical mains ;or unplug the appliance if the plug is accessible ;

- Remove the glass cover of the lamp-holder ;

- Remove the lamp and replace with a lamp resistant to high temperatures (300 °C)with the following

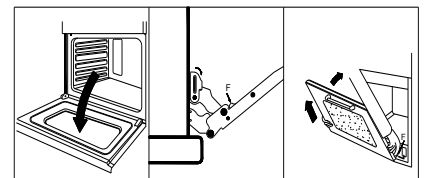
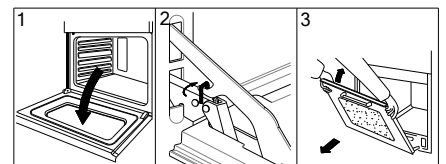

characteristics:

- Voltage: 220-240V
- Wattage: 25W
- Type: E 14

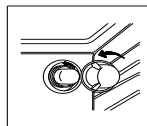

- Replace the glass cover and reconnect the oven to the mains power supply .

## Practical Cooking Advice



The oven offers a wide range of alternatives which allow you to cook any type of food in the best possible way. With time you will learn to make the best use of this versatile cooking appliance and the following directions are only a guideline which may be varied according to your own personal experience.

### Preheating

If the oven must be preheated (this is generally the case when cooking leavened foods ),the “**Multi-Cooking**” mode and the “**Fast cooking**” mode can be used to reach the desired temperature as quickly as possible in order to save on energy .

Once the food has been placed in the oven, the most appropriate cooking mode can then be selected.

### Cooking on More Than One Rack

If you have to cook food using several racks, use either the “**baking**” mode  or the “**Multi-Cooking**” mode ,as these are the only modes that allow you to do so.

When cooking delicate food on more than one rack, use the “**baking**” mode, which allows you to cook on 3 racks at the same time(the 1st 3rd and 5th from the bottom).Some examples are included in the “Practical Cooking Advice” table.

When cooking other food on several racks, use the “**Multi-Cooking**” mode keeping the following suggestions in mind:

- The oven is fitted with 5 racks .During fan assisted cooking, use two of the three central racks; the lowest and highest racks receive the hot air directly and therefore delicate foodstuffs could be burnt on these racks.
- As a general rule ,use the 2nd and 4th rack from the bottom ,placing the foodstuffs that require greater heat on the 2nd rack from the bottom .For example, when cooking meat roasts together with other food, place the roast on the 2nd rack from the bottom and the more delicate food on the 4th rack from the bottom.
- When cooking foodstuffs that require differing times and temperatures ,set a temperature that is somewhere between the two temperatures required ,place the more delicate food on the 4th rack from the bottom and take the food requiring less time out of the oven first .
- Use the dripping pan on the lower rack and the grid on the upper ;

### Using the “Fast Cooking” Mode

Functional,fast and practical for those of you who use pre-packed products (such as for example:frozen or pre-cooked food) along with other food items.You will find useful suggestions in the “Practical Cooking Advice” table.

### Using the Grill

This multi-function oven offers you **2 different grilling modes**.

Use the “**grill**” mode  , placing the food under the center of the grill (situated on the 3rd or 4th rack form the bottom )because only the central part of the top heating element is turned on .

Use the bottom rack (1st from the bottom), placing the dripping pan provided to collect any sauce and /or grease and prevent the same from dripping onto the oven bottom. When using this mode, we recommend you set the thermostat to the highest setting. However, this does not mean you cannot use lower temperatures, simply by adjusting the thermostat knob to the desired temperature.

Setting  “**fan assisted grill**” , is extremely useful for grilling foods rapidly ,as the distribution of heat makes it possible not only to brown the surface ,but also to cook the bottom part .

Moreover, it can also be used for browning foods at the end of the cooking process, such as adding that gratin finish to pasta bakes, for example.

When using this mode, place the grid on the 2nd or 3rd oven rack from the bottom (see cooking table ) then ,to prevent fat and grease from dripping onto the bottom of the oven and thus smoke from forming ,place a dripping-pan on the 1st rack from the bottom.

When using this mode ,we advise you to set the thermostat to 200°C,as it is the most efficient way to use the grill ,which is based on the use of infrared rays .However, this does not mean you cannot use lower temperatures, simply by adjusting the thermostat knob to the desired temperature.

**Therefore the best results when using the grill modes are obtained by placing the grid on the lower racks (see cooking table) then, to prevent fat and grease from dripping onto the bottom of the oven and smoke**



**from forming, place a dripping-pan on the 1st oven rack from the bottom.**

### **Baking Cakes**

When baking cakes ,always place them in a preheated oven .Make sure you wait until the oven has been preheated thoroughly (the end light “ E ” will turn off ).Do not open the oven door during baking to prevent the cake from dropping .In general:

#### **Pastry is too dry**

Increase the temperature by 10 and reduce the cooking time .

#### **Pastry dropped**

Use less liquid or lower the temperature by 10 .

#### **Pastry is too dark on top**

Place it on a lower rack, lower the temperature, and increase the cooking time.

#### **Cooked well on the inside but sticky on the outside**

Use less liquid, lower the temperature, and increase the cooking time.

#### **The Pastry sticks to the pan**

Grease the pan well and sprinkle it with a dusting of flour or use greaseproof paper.

#### **I used more than one level (in the function “ ventilated oven ” ) and they are not all at the same cooking point**

Use a lower temperature setting .It is not necessary to remove the food from all the racks at the same time.

### **Cooking Pizza**

For best results when cooking pizza ,use the“ **Pizza Mode**”  :

- Preheat the oven for at least 10 minutes ;
- Use a light aluminum pizza pan ,placing it on the grid supplied with the oven .If the dripping pan is used, this will extend the cooking time, making it difficult to get a crispy crust;
- Do not open the oven door frequently while the pizza is cooking ;
- If the pizza has a lot of toppings (three of four ),we recommend you add the mozzarella cheese on top halfway through the cooking process .
- When cooking pizza on two racks ,use the 2nd and 4th with a temperature of 220 and place the pizzas in the oven after having preheated it for at least 10 minutes .



### **Cooking Fish and Meat**







When cooking white meat ,fowl and fish ,use temperature setting from 180 to 200 .

For red meat that should be well done on the outside while tender and juicy in the inside ,it is a good idea to start with a high temperature setting (200 -220 )for a short time ,then turn the oven down afterwards.

In general, the larger the roast, the lower the temperature setting. Place the meat on the center of the grid and place the dripping pan beneath it to catch the fat.

Make sure that the grid is inserted so that it is in the center of the oven .If you would like to increase the amount of heat from below, use the low rack heights .For savory roasts (especially duck and wild game), dress the meat with lard or bacon on the top.

Selector knob setting	Food to be cooked	Weight (in kg )	Cooking rack position from bottom	Preheating time (Minutes)	Thermostat knob setting	Cooking time (Minutes )
1 Convection 	Duck	1	3	15	200	65-75
	Roast veal or beef	1	3	15	200	70-75
	Pork roast	1	3	15	200	70-80
	Biscuits (short pastry)	-	3	15	180	15-20
	Tarts	1	3	15	180	30-35
2 Multi-Cooking 	Pizza (on 2 racks)	1	2-4	15	220	15-20
	Lasagna	1	3	10	200	30-35
	Lamb	1	2	10	180	50-60
	Roast chicken +potatoes	1	2-4	10	180	60-75
	Mackerel	1	2	10	180	30-35
	Plum-cake	1	2	10	170	40-50
	Cream puffs (on 2 racks)	0.5	2-4	10	190	20-25
	Biscuits (on 2 racks)	0.5	2-4	10	180	10-15
	Sponge cake (on 1 rack)	0.5	2	10	170	15-20
	Sponge cake (on 2 racks)	1.0	2-4	10	170	20-25
Savory pies	1.5	3	15	200	25-30	

<b>3 Top Oven</b> 	Browning food to perfect Cooking	-	3/4	15	220	-
<b>4 Defrosting</b> 	All frozen food					
<b>5 Grill</b> 	Soles and cuttlefish	1	4	5	Max	8-10
	Squid and prawn kebabs	1	4	5	Max	6-8
	Cod filet	1	4	5	Max	10
	Grilled vegetables	1	3/4	5	Max	10-15
	Veal steak	1	4	5	Max	15-20
	Cutlets	1	4	5	Max	15-20
	Hamburgers	1	4	5	Max	7-10
	Mackerels	1	4	5	Max	15-20
	Toasted sandwiches	-	4	5	Max	2-3
	<b>With rotisserie</b> (where prevent)					
Veal on the spit						
Chicken on the spit	1.0	-	5	Max	80-90	
Lamb on the spit	1.5	-	5	Max	70-80	
		1.0	-	5	Max	70-80
<b>6 Fan Assisted Grill</b> 	Grilled chicken	1.5	3	5	200	55-60
	Cuttlefish	1.5	3	5	200	30-35
	<b>With rotisserie</b> (where prevent)					
	Veal on the spit					
	Chicken on the spit	1.5	-	5	200	70-80
	Chicken (on the spit)+potatoes (roasted)	2.0	-	5	200	70-80
	Lamb on the spit	1.5	-	5	200	70-75
	-	2	5	200	70-75	
	1.5	-	5	200	70-80	
<b>7 Baking</b> 	Tarts	0.5	3	15	180	20-30
	Fruit cakes	1	2/3	15	180	40-45
	Fruitcake	0.7	3	15	180	40-50
	Sponge cake	0.5	3	15	160	25-30
	Stuffed pancakes) on 2 racks)	1.2	2-4	15	200	30-35
	Small cakes (On 2 rakes)	0.6	2-4	15	190	20-25
	Cheese puffs (on2 cakes)	0.4	2-4	15	210	15-20
	Cream puffs (on 3 cakes)	0.7	1-3-5	15	180	20-25
	Biscuits (On 3 racks)	0.7	1-3-5	15	180	20-25
	Meringues (On 3 racks)	0.5	1-3-5	15	90	180
<b>8 Fast cooking</b> 	<b>Frozen food</b>					
	Pizza	0.3	2	-	250	12
	Courgette and prawn pie	0.4	2	-	200	20
	Country style spinach pie	0.5	2	-	220	30-35
	Turnovers	0.3	2	-	200	25
	Lasagne	0.5	2	-	200	35
	Golden Rolls	0.4	2	-	180	25-30
	Chicken morseis	0.4	2	-	220	15-20
	<b>Pre-cooked food</b>					
	Golden chicken wings	0.4	2	-	200	20-25
	<b>Fresh Food</b>					
	Biscuits(short pastry)	0.3	2	-	200	15-18
	Fruitcake	0.6	2	-	180	45
Cheese puffs	0.2	2	-	210	10-12	
<b>9 Pizza</b> 	Pizza	0.5	3	15	220	15-20
	Roast veal or beef	1	2	10	220	25-30
	Chicken	1	2/3	10	180	60-70

**NB:**cooking times are approximate and may vary according to personal taste .When cooking using the grill or fan

assisted grill ,the dripping pan must always be placed on the 1st oven rack from the bottom .

### **Safety Is A Good Habit To Get Into**

**To maintain the efficiency and safety of this appliance, we recommend that you do the following:**

- **only call the Service Centers authorized by the manufacturer**
- **always use original spare parts**
- **in case of damage to the power cord, a special purpose cord or component bought from the manufacturer or maintenance department shall be used for replacement**

**When handling the appliance, we recommend you always use the purpose provided handles recessed into the sides of the oven to prevent harming people or damaging the appliance itself.**

- This appliance is designed for non-professional ,house-hold use and its functions must not be changed .
- The electrical system of this appliance can only be used safely when it is correctly connected to an efficient earthing system in compliance with current safety standards .

• **When the appliance is in use ,the heating elements and some parts of the oven door become extremely hot .Make sure you don't touch them and keep children well away.**

- **Heat will be generated during its working. Caution must be observed to avoid touch of the heating element.**

**The following items are potentially dangerous, and therefore appropriate measures must be taken to prevent children and the disabled from coming into contact with them:**

- Controls and the appliance in general;
- Packaging (bags, polystyrene, nails, etc.);
- The appliance itself, immediately after use of the oven or grill due to the heat generated;
- The appliance itself, when no longer in use (potentially dangerous parts must be made safe).

**Avoid the following:**

- Touching the appliance with wet parts of the body;
- Using the appliance when barefoot;
- Pulling on the or the supply cable to unplug it from the electrical outlet;
- Improper or dangerous operations;
- Obstructing the ventilation or heat dissipation slots;
- Allowing power supply cables of small appliances to come into contact with the hot parts of the appliance;
- Exposing the appliance to atmospheric agents such as rain, or sunlight;
- Using the oven for storage purposes;
- Using flammable liquids near the appliance;
- Using adapters, multiple sockets and /or extension leads;
- Attempting to install or repair the appliance without the assistance of qualified personnel.



**Qualified personnel must be contacted in the following cases:**

- Installation (following the manufacturer's instructions);
- When in doubt about operating the appliance;
- Replacing the electrical socket when it is not compatible with the appliance plug.
- The temperature probe is a part of thermostat, if damaged; they shall be replaced overall by authorized service person.

**Service Centers authorized by the manufacturer must be contacted in the following cases:**

- If in doubt about the soundness of the appliance after removing it from its packaging;
- If the power supply cable has been damaged or needs to be replaced;
- If the appliance breaks down or functions poorly; ask for original spare parts.

**It is a good idea to do the following:**

- Steam cleaner cannot be used to clean the oven;
- Only use the appliance to cook food and nothing else;
- Check the soundness of the appliance after it has been unpacked;
- Disconnect the appliance from the electrical mains if it is not functioning properly and before cleaning or performing maintenance;
- When left unused, unplug the appliance form the electricity mains;
- Use oven gloves to place cookware in the oven or when removing it;
- Always grip the oven door handle in the center as the extremities of the same may be hot due to any hot air leaks;
- Make sure the knobs are in the “  ” / “  ” position when the appliance is not in use ;
- Cut the power supply cable after disconnecting it from the mains when you decide not to use the appliance any longer.

- The manufacturer may not be held responsible for any damage due to :Incorrect installation, improper, incorrect and irrational use.

### Installation

**Only a qualified person in compliance with the instructions provided must install the appliance.** The manufacturer declines all responsibility for improper installation, which may harm persons and animals and damage property.

**Important:** - The power supply to the appliance must be cut off before any adjustments or maintenance work is done on it;  
 - Air duct is supposed to use in Ventilation.

### Installation of Built-in Ovens

In order to ensure that the built-in appliance functions properly, the cabinet containing it must be appropriate .The figure below gives the dimensions of the cut-out for installation under the counter or in a wall cabinet unit.

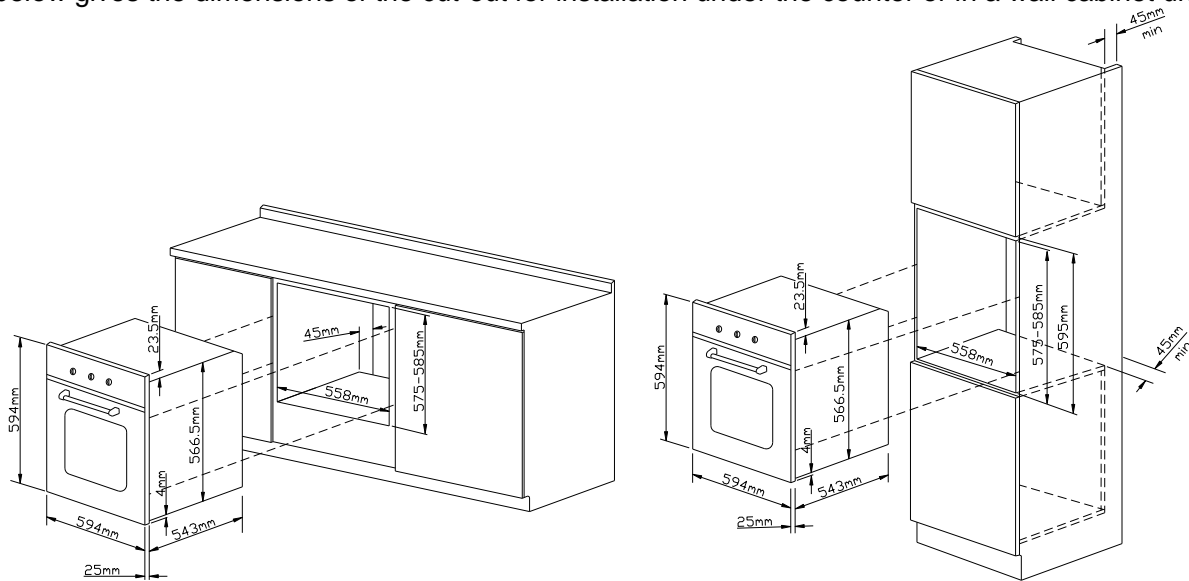

N. B :Installation in compliance with the consumption declaration

In order to ensure adequate ventilation ,the back panel of the cabinet unit must be removed .Installing the oven so that it rests on two strips of wood is preferable .If the oven rests on a continuous ,flat surface ,there must be an aperture of at least 45×560mm .

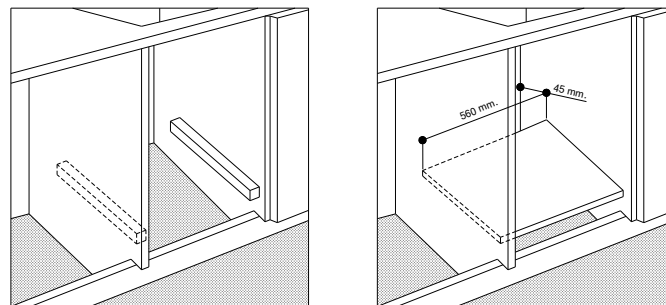

The panels of the adjacent cabinets must be made of heat-resistant material .In particular ,cabinets with a veneer exterior must be assembled with glues which can withstand temperatures of up to 100°C .

In compliance with current safety standards, contact with the electrical parts of the oven must not be possible once it has been installed.

All parts, which ensure the safe operation of the appliance, must be removable only with the aid of a tool.

To fasten the oven to the cabinet, open the door of the oven and attach it by inserting the 4 wooden screws into the 4 holes located on the perimeter of the frame.

### Electrical Connection

Those ovens equipped with a three-pole power supply cable are designed to operate with an alternating current .The wire for earthing the appliance is yellow-green in color.

### Fitting on a Power Supply Cable

Opening the terminal board:

- Using a screwdriver ,prize the bolt on the side tabs of the terminal board cover ;

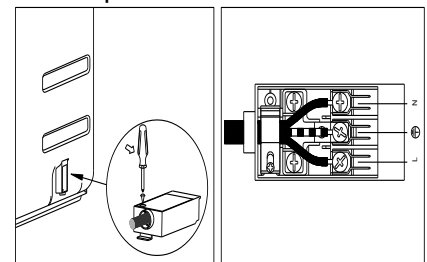

- Unscrew the bolt, pull open the cover of the terminal board .

To install the cable, proceed as follows:

- Remove the wire clamp screw and the three contact screws **L-N** -  $\perp$
- Fasten the wires beneath the screw heads using the following color scheme :**Blue (N) Brown (L) Yellow-Green**  $\perp$
- Fasten the supply cable in place with the clamp and close the cover of the terminal board .

### Connecting the supply cable to the mains

Install a standardized plug corresponding to the load indicated on the data plate. When connecting the cable directly to the mains, install an omni polar circuit breaker with a minimum contact opening of 3 mm between the appliance and the mains .The omni polar circuit breaker should be sized according to the load and should comply with current regulations (the earth wire should not be interrupted by the circuit breaker).

The supply cable should be positioned so that it does not reach a temperature of more than 50°C with respect to the room temperature ,anywhere along its length , or protected by insulation sleeping having an appropriate rating.

Before making the connection, check that:

- The electrical safety of this appliance can only be guaranteed if the cooker is correctly and efficiently earthed ,in compliance with regulations on electrical safety. Always ensure that the earthing is efficient; if you have any doubts call in a qualified technician to check the system .The manufacturer declines all responsibility for damage resulting from a system which has not been earthed.
- Before plugging the appliance into the mains ,check that the specifications indicated on the date plate (on the appliance and /or packaging )correspond to those of the electrical mains system of your home .
- Check that the electrical capacity of the system and sockets will support the maximum power of the appliance ,as indicated on the data plate .If you have any doubts, call in a qualified technician.
- If the socket and appliance plug are not compatible ,have the socket replaced with a suitable model by a qualified technician . The latter, in particular, will also have to ensure that the cross section of the socket cables are suitable for the power absorbed by the appliance. The use of adapters, multiple sockets and /or extensions, is not recommended. If their use cannot be avoided, remember to use only single or multiple adapters and extensions which comply with current safety regulations .In these cases, never exceed the maximum current capacity indicated on the single adapter or extension and the maximum power indicated on the multiple adapter .**The plug and socket must be easily accessible.**

### Technical Specifications

#### Inner dimensions of the oven:

Width 43.5cm  
Depth 40cm  
Height 32cm

#### Inner Volume of the oven 56 liters

#### Voltage and Frequency of Power Supply:

220-240V ~50/60Hz or 50Hz

  
 2100-2520W 2090-2520W 2100-2550W 2772-3420W 1660-2020W 2125-2560W 1220-1460W 940-1110W 2370-2924W 45-55W



Meaning of crossed –out wheeled dustbin:

Do not dispose of electrical appliances as unsorted municipal waste, use separate collection facilities.

Contact you local government for information regarding the collection systems available.

If electrical appliances are disposed of in landfills or dumps,hazardous substances can leak into the groundwater and get into the food chain,damaging your health and well-being.

When replacing old appliances with new ones, the retailer is legally obligated to take back your old appliance for disposals at least free of charge.

For after sales service, please contact:

Casa (S) Pte Ltd  
15 Kian Teck Crescent,  
Singapore 628884  
Tel: + 65 6268 0077  
Email: [service@casa.com.sg](mailto:service@casa.com.sg)