

## **WARRANTY & SERVICE**

- To activate your warranty, please register your appliance.
- Warranty registration can be done via our website or scan the QR code below.

### **Website**

<https://shop.casa.sg/E-Warranty>

### **QR Code**

Scan the QR Code below. It will redirect straight to our “Warranty Registration” page.



Casa (S) Pte Ltd. reserves the rights to the final interpretation of the content of this manual. Customer will not be notified in the event of any amendments to the content.

The manufacturer and agent decline all responsibilities in the event of damage caused by improper, incorrect or illogical use of the appliance.

Contact customer care center when in doubt of the condition of the appliance. Please get ready the model number of your appliance, date of purchase and the product issue when contacting customer care center.

For customer care / after sales service [Singapore], please contact

**Casa (S) Pte Ltd**

15, Kian Teck Crescent, Singapore 628884

**Whatsapp:** +65 9747 8743

**Fax:** +65 6898 0510

**Email:** [service@casa.com.sg](mailto:service@casa.com.sg)



## **Embracing Finest Moments**

Top-Load  
Washing Machine

## **INSTRUCTION MANUAL**

EFWT 1091G WP/EFWT 1291DDG WP

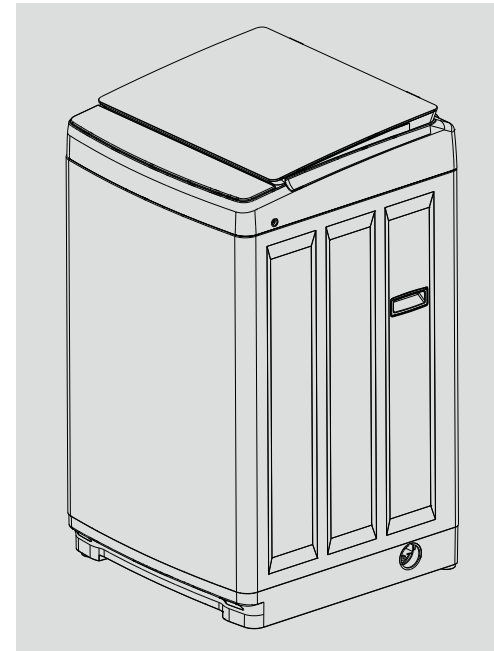











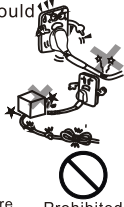

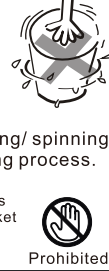
**PLEASE READ THIS MANUAL CAREFULLY BEFORE USING THIS PRODUCT  
PLEASE FOLLOW ALL SAFETY RULES AND OPERATING INSTRUCTIONS**

# CONTENT

IMPORTANT SAFETY INSTRUCTIONS .....	1-2
PRODUCT OVERVIEW .....	3
INSTALLATION... ..	4-6
CONTROL PANEL.....	7-8
OPERATION .....	9-12
GENERAL MAINTENANCE.....	13
TROUBLESHOOTING .....	14
TECHNICAL SPECIFICATION .....	15
WARRANTY & SERVICE .....	16

# IMPORTANT SAFETY INSTRUCTIONS

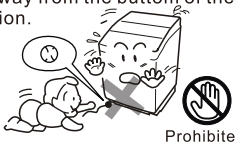
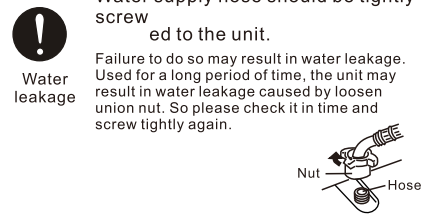
<b>⚠ Warning</b>	
<ul style="list-style-type: none"> <li>● Dismantle, repair or alterations should only be carried out by professional technicians. Avoid electric shock, fire, and body injury due to improper activity.</li> </ul>	<ul style="list-style-type: none"> <li>● This washing machine is equipped with the electricity wire with bielectrode grounding socket. The creepage protector shall be used if possible. To prevent electricity leak which may cause injuries.</li> </ul> 
<ul style="list-style-type: none"> <li>● Electricity supply must be unplugged with dry hands. Otherwise, this may cause electric shock.</li> </ul> 	<ul style="list-style-type: none"> <li>● Do not put water in direct contact with the unit during maintenance and repair. This may cause short circuit or electric shock.</li> </ul> 
<ul style="list-style-type: none"> <li>● Damaged or loosen wire or plug should not be used. Otherwise electric shock, short circuit or fire may take place.</li> <li>● Do not damage wire. DO not damage or alter the wire forcibly bend, pull twist or handle the wire. Beside, please do not put weight on or trap the wire. Damage of wire may case electric shock or fire.</li> </ul> 	<ul style="list-style-type: none"> <li>● Do not put gasoline, benzine, alcohol, thinner of fabrics with these stains into or near to the washing machine. To prevent fire or explosion which may cause injuries.</li> </ul> 
<ul style="list-style-type: none"> <li>● Keep child away from the washing spinning basket and do not place box or shelves next to the washing machine. children may fall into the basket resulting in injuries.</li> </ul> 	<ul style="list-style-type: none"> <li>● Do not put your hand into the basket until it has stopped completely. Even when the spinning of the basket is slow, there is still a danger of being caught in the motion, resulting injuries. Particular attention should be paid when children are around.</li> <li>● Do not put your hands into the washing/ spinning basket during the washing and rinsing process. Even when the spinning is slow, hands may be trapped by clothes. If necessarily, please press pause button, and put your hands into the basket after it has stopped completely.</li> </ul> 
<ul style="list-style-type: none"> <li>● Please use the single socket with special voltage and current matched with plug marked specification. The share of the same socket with other electric appliances may cause fire due to excessive.</li> </ul>	<ul style="list-style-type: none"> <li>● Thoroughly wipe the power plug when dirt is adhering the prong or around the base of the prong. Clear Failure to do so may cause a fire.</li> </ul>
<ul style="list-style-type: none"> <li>● Washing machine should not be installed in humid place or in places exposed to wind and rain. Otherwise, electricity leak causing electric shock or fire may occur.</li> </ul> 	<ul style="list-style-type: none"> <li>● This washing machine is strictly prohibited to get close to the locations with candle, mosquito-repellent incense, dog-end or other kinds of open flame. To avoid injuries caused by the lock damage.</li> </ul> 

<ul style="list-style-type: none"> <li>● Do not pull the wire from the socket when unplugging the unit. To avoid electric shock or fire cause by short circuit may result.</li> </ul> 	<ul style="list-style-type: none"> <li>● Please unplug the unit when not using the unit for a long period of time. Electric shock or leakage may occur due to deformation of plastic parts of the unit.</li> </ul>
<ul style="list-style-type: none"> <li>● Electricity supply must be unplugged with dry hands during maintenance and repair. Otherwise, electric leakage causing injuries may occur.</li> </ul>	<ul style="list-style-type: none"> <li>● Water of above 50°C should not be used for washing. Electric shock or leakage may occur due to deformation of plastic parts of the unit.</li> </ul> 
<ul style="list-style-type: none"> <li>● Do not wash, rinse and spin the water proof fabric or cloth. Sleeping bag, raincoat, cover of skiing, utilities, bicycles, cars and motors. Otherwise may lead to injury by abnormal vibration during spinning or damage the washing machine, wall, floor and clothes.</li> </ul> 	<ul style="list-style-type: none"> <li>● Do not stand on or put weight on the top of the unit. Otherwise, deformation and damage may result causing injuries.</li> </ul> 
<ul style="list-style-type: none"> <li>● Keep hands and feet away from the bottom of the washing when it is motion. Ports in motion beneath the unit may cause injuries.</li> </ul> 	<ul style="list-style-type: none"> <li>● Check water supply hose connection by turning on the water before washing. To prevent damages caused by possible water leakage due to loosen screw or not tightly.</li> </ul>
<ul style="list-style-type: none"> <li>● Water supply hose should be tightly screw ed to the unit. Failure to do so may result in water leakage. Used for a long period of time, the unit may result in water leakage caused by loosen union nut. So please check it in time and screw tightly again.</li> </ul> 	<ul style="list-style-type: none"> <li>● Please turn off the water tap when not using the unit. To prevent damages caused by water leakage.</li> </ul> 
<ul style="list-style-type: none"> <li>● This appliance is intended to be used in household and similar applications such as: (IEC 60335-2-7) -Staff Kitchen area in shops, offices and other working environments; -Farm Housed; -By clients in hotels, motels and other residential type environments; -Bed and breakfast type environments; -Area for communal use in blocks of flats or in launderettes.</li> </ul>	<ul style="list-style-type: none"> <li>● -The appliance is not to be used by person (including children) with reduced physical, sensory or mental capabilities, or lack of experience and knowledge, unless they have been given supervision or instruction. -Children being supervised not to play with the appliance.</li> </ul>

# PRODUCT OVERVIEW

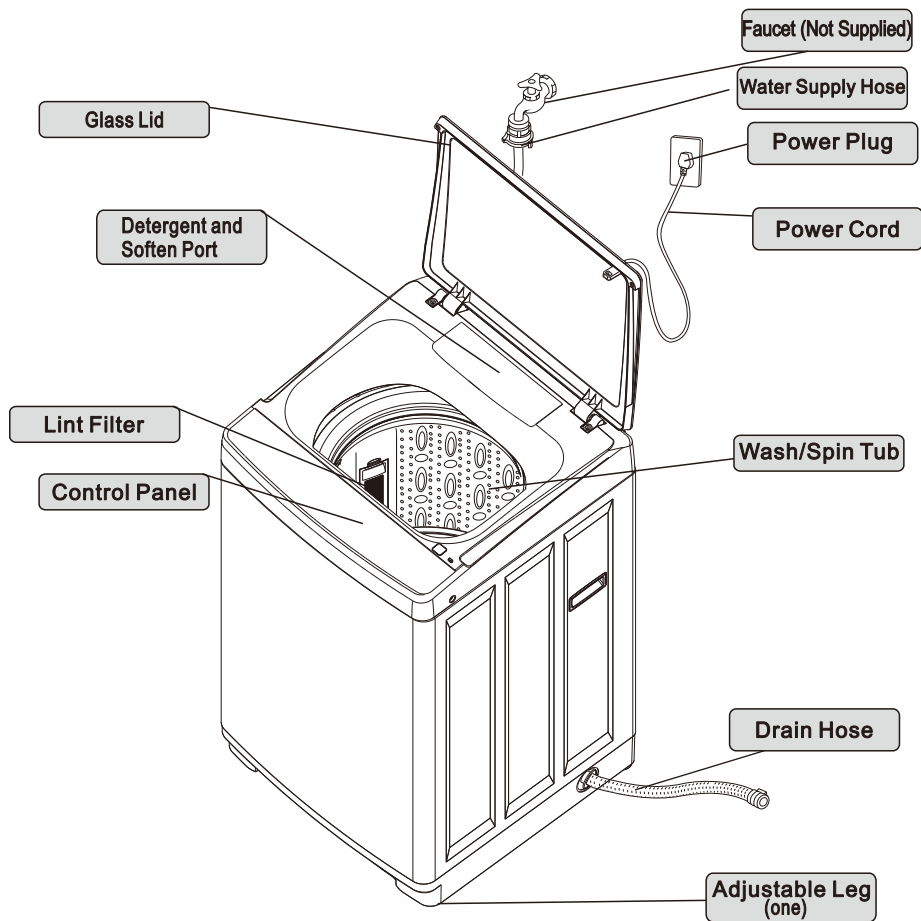

## Supplied Accessories

Operation manual	Drain Hose	Water Supply Hose	Bottom Cover

# INSTALLATION

## Installing the Bottom Cover

1. Unplug the Power Cord of the washer.
2. Gently lay down the backside of washer on a soft mat or cushion. (Be careful not to dent the Frame.)
3. Insert the attached Bottom Cover into the hooks of Leg by straightly pushing until it reaches into the back hooks.
4. Fasten the Bottom Cover with a screw.
5. Gently set the washer upright.

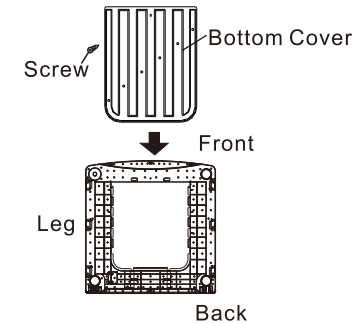

## Location of Washer

1. The location of washer must remain dry and away from direct sunlight or rain.
2. Install the washer on a stable and level surface.



3. Adjust the Adjustable Leg of washer if necessary to make the washer level as shown in the figure.



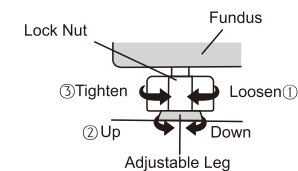

The maximum permissible inclination of the supporting surface is 2°.

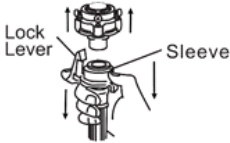
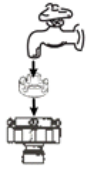
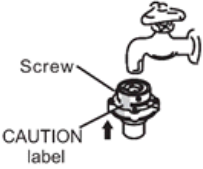

## CAUTION:

- DO NOT BLOCK THE VENTILATION OPENINGS UNDER THE WASHER, WASHER WILL BE DAMAGED IF VENTILATION IS BLOCKED.

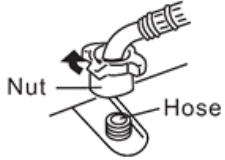
## Installation of water supply inlet hose

<p><b>Step 1</b></p>  <p>Lock Lever Sleeve</p>	<p><b>Step 2</b></p> 
<p>Detach the joint hose from the water supply hose.</p>	<p>Sleeve the joint ring over the tap and align with the joint hose. Make sure it is centered.</p>
<p><b>Step 3</b></p>  <p>Screw CAUTION label</p>	<p><b>Step 4</b></p> 
<p>Once align, screw in the four screws that will secure the joint hose on the tap.</p>	<p>Remove the caution label, turn the bottom part of the join hose counter anticlockwise and ensure it is tight so there is seal in between the join hose and tap.</p>
<p><b>Step 5</b></p>  <p>Nut Hose</p>	<p><b>Step 6</b></p> 
<p>Take the other end of the hose and screw clockwise into the washer inlet. Make sure it is tight to prevent water leakage.</p>	<p>Once all is done, Do a quick check on pulling the join hose to ensure it is tight and not lose.</p>

## Installation of drain hose

1. Make sure the washer and water supply are off and start locating the drain hose connector.
2. Pinch the two bands of the clamp from the drain hose connector. Connect the given drain hose in to the connector.
3. Once connected, put the other end of the hose into the drain spout.

**Note: Please take the drain hose out of the water spout when washer is not being used for a long period of time.**



## Changing the position of the drain hose

Depending on the use of location, the drain hose can be changed from being on the right side to being on the left side.

1. Remove the cap on the Drain Mouth on the left.
2. Lay the Washing Machine backward down on a soft cushion.
3. Loosen the Hose Clamp and unplug the Inner Drain Pipe from the Drain Valve.
4. Push the joint on the Drain Mouth and pull the Inner Drain Pipe out of the Drain Mouth on the right side of the Washing Machine.
5. Insert the Inner Drain Pipe from the Drain Mouth on the left side and snap the joint.
6. Connect the Inner Drain Pipe to the Drain Valve and fix it with the Hose Clamp.
7. Install the Drain Mouth Cap on the left in the appropriate position on the right.
8. Lift the Washing Machine gently until it is placed steadily.

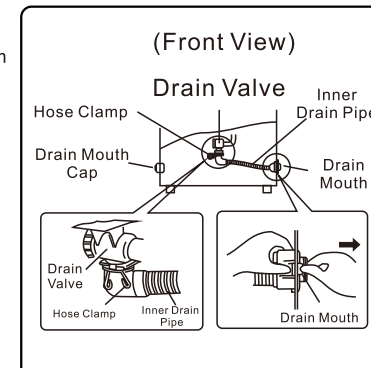

**Note:** The default position of the drain hose is on the right side. Before changing to the left side, unplug the Power Cord.

**To Prevent hand scratches or injuries, please wear gloves.**

## Extension of the Drain Hose





Make sure the length of the drain hose is enough, extension of drain hose is permitted and not supplied.

Extension of the Drain Hose	Extension Height	Extension Length	
There is a step in the middle	Within 15cm	Within 1m	
There are no steps in the middle	—	Within 3m	

# CONTROL PANEL

### DETERGENT Indication

- These are the spoon indications of the DETERGENT volume for different water level

	.....	7-8
	.....	5-6
	.....	3-4
	.....	1-2

### Digital Display

- The digital display shows the remaining time of the program, and the currently selected option.
- When an abnormal condition occurs, it shows the warning code, e.g: Water does not flow
- When press the water level, it shows the water level you set.

(E.g.) Remaining time is 20 minutes 20

(E.g.) Water does not flow E1

(E.g.) Water level is 8 levels 8

### WATER LEVEL Button

- You can choose the appropriate water level that matches the load size. (Refer to table in page 9)

### START/PAUSE Button

- Press this button to start the washing machine.
- To pause the program, press this button again to temporarily stop the operation.
- To restart the washer operation, press this button again.

**NOTES:**

- This is not a CANCEL button.
- When pause is activated, the function indicator will be blinking. If it is not blinking, pause is deactivated.

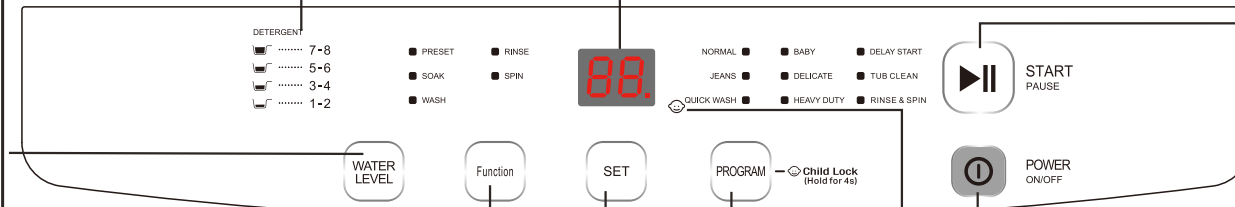

### Function Button

- The Function button can be used to select "PRESET", "SOAK", "WASH", "RINSE", "SPIN" process.

### SET Button

- Press SET buttons to adjust the washing time of PRESET, SOAK, WASH, SPIN and the number of times to RINSE.

### PROGRAM Button

- To choose the washing program, press PROGRAM button.

**NOTE:**

- If you choose the NORMAL, HEAVY Duty, QUICK WASH, JEANS, BABY program, the washer will automatically begin the NEURO & FUZZY operation.
- When setting the child lock function, the child lock indicator light up

(E.g.) child lock light up 

### CHILD LOCK

### POWER ON/OFF Button

- Press this button to turn on or off the power.
- The washer will be turned off automatically in 5 seconds after the washing is completed.
- If you leave the washer turn on without starting operation, the power will be turned off automatically after 10 minutes.

# OPERATION

## Preparation of laundry before washing

- Make sure that nothing is remained in pocket. (Pin, coin or something like possibly damage clothes or washer.)
- Wool items like women lingerie articles with embroider, nylon etc, should be placed in a laundry net for extra protection.
- Always separate white or lighter coloured clothes from coloured clothes, coats from lingerie. It is to prevent dye from the darker coloured clothing seep into lighter coloured clothing during the washing process and light clothing can turn into off-shade colours and be ruined.

## Auto program

The washing machine comes with auto sensing that will auto detect the laundry load with appropriate water level, wash, spin and rinse time accordingly.

Auto Sensing Programs				
NORMAL	JEANS	QUICKWASH	BABY	HEAVY DUTY

1. Select the preferred wash program. (**NORMAL, JEANS, QUICKWASH, BABY AND HEAVYDUTY**)
2. Then press “**Start**” button.
3. The Machine will then start operating after sensing the appropriate water level, wash and spin time.

## Detergent guideline

Water Level	1	2	3	4	5	6	7	8
Water Volume(Approx. L)	20	25	30	36	42	48	54	60
Detergent Indicators								
Powdered detergent volume (g)	12~25	25~35	35~50	50~70				
Other detergent volume	You may adjust the detergent volume according to the type of detergent-follow recommendations on package.							

**Note: Too much detergent causes poor rinsing and too little detergent causes poor washing.**

## Program table

EFWT 1091G WP					
Program	Description	Capacity (kg)	Duration	No. of Rinse	Spin Time
NORMAL*	Normal dirty clothes	10	Depending on load	2	6min
JEANS	Suitable for washing jeans	4	55min	2	6min
QUICKWASH	Not very dirty clothes	3	27min	1	3min
BABY	Suitable for children's clothes	7	65min	3	6min
DELICATE	Suitable for gentle washing of fine fabrics	3	31min	2	2min
HEAVY DUTY	Dirty clothes like heavily soiled clothes	7	Depending on load	2	8min
BLANKET	Suitable for washing large household textiles	4	67min	3	8min
TUB CLEAN (Do not add clothes)	Wash the tub to keep the freshness	0	2hr	1	3min
RINSE & SPIN	Extra spin & rinse	10	34min	2	6min

EFWT 1291DDG WP					
Program	Description	Capacity (kg)	Duration	No. of Rinse	Spin Time
NORMAL*	Normal dirty clothes	12	Depending on load	2	5min
JEANS	Suitable for washing jeans	4	55min	2	5min
QUICKWASH	Not very dirty clothes	3	28min	1	3min
BABY	Suitable for children's clothes	7	65min	3	5min
DELICATE	Suitable for gentle washing of fine fabrics	3	32min	2	2min
HEAVY DUTY	Dirty clothes like heavily soiled clothes	7	Depending on load	2	8min
BLANKET	Suitable for washing large household textiles	4	68min	3	8min
TUB CLEAN (Do not add clothes)	Wash the tub to keep the freshness	0	2hr	1	3min
RINSE & SPIN	Extra spin & rinse	12	34min	2	5min

**Note: Duration is default, customers can customise according to their preferred function.**

The program “Normal\*” with Water Level 8 is able to clean normally soiled cotton laundry. “Normal” with Water Level 8 is recommended program designed to minimize water consumption for normally soiled load at rated capacity. You can use this program by adjusting manually the water level to 8.

## Function

Each programs have its own amount of duration and number of times that can be fully customised by user.

Functions	Programmable time
Preset	1-24hr
Soak	10mins, 20mins, 30mins, 40mins
Wash	1-20mins
Rinse**	"1", "1.", "2", "2.", "3", "3.", "4", "4".
Spin	1-9mins

**Note: \*\* There are two methods of rinsing for the washer.**  
**"1" is rinse 1 time with water stored in drum.**  
**"1." Is rinse 1 time with water flowing.**

## How to adjust the functions

Follow the flow chart on how to tune to your washing preference.

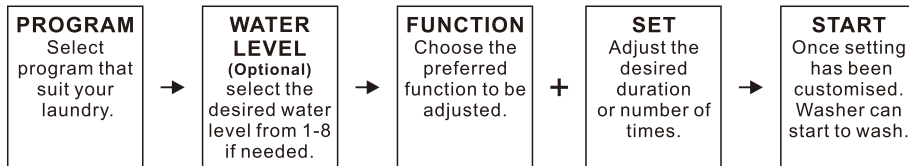

**PROGRAM:** Select any program that you require for your laundry (NORMAL, JEANS, QUICKWASH, BABY, DELICATE, HEAVY DUTY, BLANKET, TUB CLEAN, RINSE & SPIN) mount of duration and number of times that can be fully customised by user.

**WATER LEVEL:** Adjust water level from 1-8 according to what your laundry require.

**FUNCTION + SET:** Choose the preferred function (PRESET, SOAK, WASH, RINSE OR SPIN) to be customised by pressing the "FUNCTION" button. The indicator besides the chosen function will blink, indicating that the function is being selected. Adjust the duration or number of times by pressing "SET" button.

**Note: Adjustment can be done only while the indicator on the selected function is blinking.**

**Repeat the above steps to adjust all other function to suit your washing preference.**

Example:

To adjust the "wash" duration to 15minutes under "normal" program.

1. Select "Normal" program.
2. Press the "function" button until the indicator besides "wash" function is blinking.
3. Press the set "Set" button to adjust the wash duration to 15minutes (The display panel will show "15").
4. Press "Start/Pause" button once the program is being customised.

**START:** Once you have customised to your washing program and function. You can start the program by pressing "START/PAUSE".

## Preset

This is **delay End function**; wash cycle can be programmed to end at a later time after user set the preferred ending hours. You may choose to end the washing cycle from **1 - 24hrs.**



To use preset function,

1. Press "Power" button
2. Press "Program" button and choose the required program that suits your washing.
3. Press "Function" button until the red indicator is blinking besides the "Preset".
4. Press "Set" Button and adjust the preferred ending time (From 1-24hrs).
5. Press "Start/Pause" button to start the program.

## Deactivation of End Buzzer

Upon completion of each program, there will be acoustic signal indicating the program is completed. You may deactivate the acoustic signal (End Buzzer)

- **To Deactivate Buzzer** after washing machine operation is completed  
Press and Hold Start/Pause button for 5seconds until you hear a "beep" then release the button after "beep" sound.
- **To Reactivate buzzer** after washing machine operation is completed  
Press and Hold Start/Pause button for 5 seconds until you hear a "beep" then release the button.

## Child Lock

Child lock function is to prevent accidental adjustment of water level during the washing operation.

**Note: Child lock works only during washing operation.**





**Child lock only disable water level adjustment during operation.**

**To activate child lock,** Press and hold "Program" button for 4 second until the child lock indicator light is on.

**To deactivate child lock,** Press and hold "Program" button for 4 second until the child lock indicator light is off.

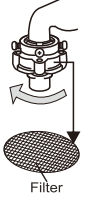

# GENERAL MAINTAINENCE

<p><b>Clean washing machine</b> Use soft clothing to wipe off the water or dirt on the surface of the washer.</p> <ul style="list-style-type: none"> <li>Do not spray water directly to the washer body.</li> <li>Detergent, propellant and other chemicals are not allowed to use to avoid the damages on the surface.</li> </ul> 	<p><b>Clean the water inlet Valve</b> (Suggest clean it every 6 months) After long time use, The water inlet mesh bag may be blocked with crud, please load off the water inlet hose, take out the water inlet mesh bag from the water inlet valve, clean the mesh bag, then assemble the mesh bag in the valve and load the water inlet hose.</p>  <p>Water Inlet</p>
<p><b>Clean Hose Filter</b> (Suggest clean it every 6 months)</p> <ol style="list-style-type: none"> <li>Pull the water inlet hose out.</li> <li>Turn off the revolver according to the figure shown.</li> <li>Load off the "Magic" Hose Joint filter and clean the crud with a toothbrush.</li> <li>Install the clean "Magic" Hose Joint filter to revolver and water inlet hose.</li> </ol>  <p>Filter</p>	<p><b>Clean lint filter</b> (Suggest clean it every week)</p> <ol style="list-style-type: none"> <li>Take out the lint filter.</li> <li>Pull out the scraps and wash the lint filter in the water.</li> <li>Install the Filter ( aim the frame claw to the groove below).</li> </ol> <p>(Be gentle with the Lint Filer as it is fragile.)</p> 

# TROUBLESHOOTING

Error Code	Fault	Possible causes	Action
	<b>The washer is not working.</b>	Power supply is not present.	<ul style="list-style-type: none"> <li>Press the on off button.</li> <li>Connect power supply.</li> <li>Check circuit breaker is on or fuse broken.</li> </ul>
		Washer is set to preset.	<ul style="list-style-type: none"> <li>Press the on/off button to reset program.</li> </ul>
E1	<b>Water does not flow into tub or water flow is slim.</b>	Water supply cut off.	<ul style="list-style-type: none"> <li>Connect to water supply</li> <li>Turn on water supply.</li> </ul>
		Metal filter in water inlet is clog.	<ul style="list-style-type: none"> <li>Clean the metal filter by removing any dirt that is blocking.</li> </ul>
		Water pressure is low.	<ul style="list-style-type: none"> <li>Adjust water supply pressure.</li> </ul>
E2	<b>Water does not drain out.</b>	Height of drain hose is too high.	<ul style="list-style-type: none"> <li>Lower the drain hose</li> </ul>
		Drain hose clog.	<ul style="list-style-type: none"> <li>Removing any dirt that is blocking.</li> </ul>
		Drain hose is has been squashed.	<ul style="list-style-type: none"> <li>Remove and heavy object that is touching the drain hose.</li> </ul>
E3	<b>Washer does not spin.</b>	Laundry is clumped on one side of the tub.	<ul style="list-style-type: none"> <li>Put lesser load or reposition the laundry in the drum.</li> </ul>
		Washer is not on a level surface.	<ul style="list-style-type: none"> <li>Level the washer correctly or choose a location that is level for the washer.</li> </ul>
E4	<b>Washer lid is open.</b>	Washer lid is open.	<ul style="list-style-type: none"> <li>Close the lid and press start button again.</li> </ul>
E5	<b>Washer does not wash.</b>	Washer lid is open	<ul style="list-style-type: none"> <li>Close the lid and press start button again.</li> </ul>
		Washer is under child lock.	<ul style="list-style-type: none"> <li>Press and hold the Program button for 5 second to unlock.</li> </ul>
EA	<b>Other Faults</b>		<ul style="list-style-type: none"> <li>Off the washer and call CASA after sales service centre.</li> </ul>
EC			

## Note:

- During Washing or Rinsing, there is still Water inletting. This is possibly automatic water adding due to water level decrease.
- Spin tub turns or stops timely at the beginning of spinning. This is intermittent spinning for better spin effect.
- Water is inletting and rinsing sometimes during spinning. This is automatic lean-correction due to clothe is not equally inside.
- There is sound like water flow after spinning. This is the sound of balance liquid in Balance Ring. It is for reducing vibration of spinning.
- Control panel keeps warm after power off, this is caused by Remembering circuitry working.

# TECHNICAL SPECIFICATION

## EFWT 1091G WP

Capacity	10KG
Dimensions	540(W)x568(D)x955 (H) mm
Net weight	34kg
Input voltage & Frequency	230-240V/50Hz
Power Consumption	420W
Required Water Pressure	0.03 MPa ~ 0.8 MPa (0.3 kgf/cm <sup>2</sup> ~ 8 kgf/cm <sup>2</sup> )

## EFWT 1291DDG WP

Capacity	12KG
Dimensions	570(W)x593(D)x985 (H) mm
Net weight	39kg
Input voltage & Frequency	220-240V/50Hz
Power Consumption	420W
Required Water Pressure	0.03 MPa ~ 0.8 MPa (0.3 kgf/cm <sup>2</sup> ~ 8 kgf/cm <sup>2</sup> )