

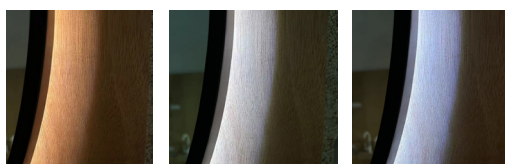









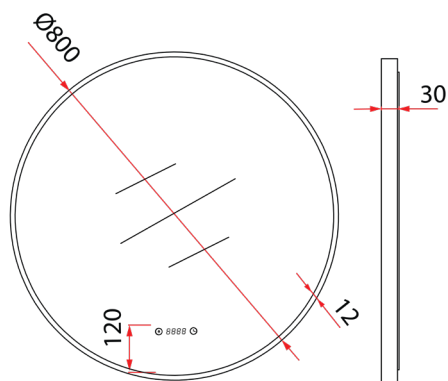

Rubine's ACO LED Mirror offers three light color options: warm, neutral, and white. Its 5mm thickness means it's durable and sturdy. These mirrors are lightweight, non-metallic, and corrosion-resistant, perfect for bathrooms. You can easily control the lighting with a simple touch, no buttons needed. Adjust the brightness smoothly to suit your preference, from soft ambient light to bright illumination.

No more foggy mirrors! The built-in demister keeps it clear, even in steamy conditions, ideal for makeup and shaving. It's splash-proof, protecting against water and dust. Plus, with a two-year warranty, you're covered against any manufacturing defects, giving you peace of mind.



Warm Light Natural Light White Light



-  2xTouch Sense Switch
-  IP44 Rated
-  Stepless Dimming
-  Quick & Easy Installation
-  Tricolor LED
-  5mm Non-metallic Mirror
-  Demister
-  2 Years Warranty
-  Clock
-  CE Approved

* Measured in Millimeters (mm)
 * Product dimension is for reference only.
 * Kindly allow 1-3cm of difference in actual product.

Product Information	
Model	RBM-ACO R80LED-BK
Frame Material	Aluminum
Colour	Matte Black
Installation	Wall-Mounted
Overall Dimension	Dia 800 x 30mm
Weight	8.4kg
Package Included	Mirror + Mounting Hardware
Warranty (T&C's Apply)	2 years on mirror desilvering

*Copyright. All Rights Reserved. Rubine is constantly improving its products and make changes if deemed necessary.