

BUILT-IN INDUCTION HOB

Model:

HB BI 293 G



EMBRACING FINEST MOMENT

USER MANUAL

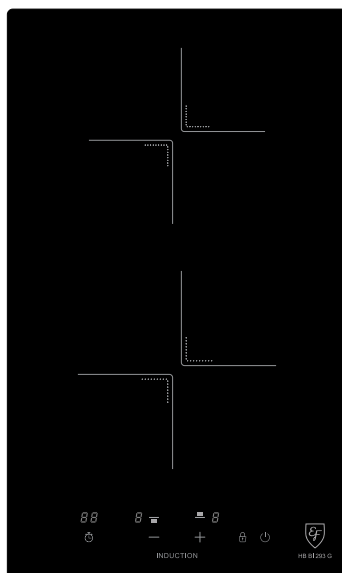

Dear Customer,

Thank you for having purchased and given your preference to our product. This manual provides a means to make full use of the features of this product. The safety precautions and recommendations are also featured in this manual. We recommend that you read this manual for best performance and to extend the life of your appliance.

Please preserve this manual for future use, in the event that doubts arise relating to the operation.

SAFETY GUIDELINES

IMPORTANT: This appliance is designed and manufactured solely for the cooking of domestic (household) food and is not suitable for any non-domestic application and therefore should not be used in a commercial environment.

The appliance guarantee will be void if the appliance is used within a non-domestic environment i.e. A semi commercial, commercial or a communal environment.

Installation

Electrical Shock Hazard

- Disconnect the appliance from the mains electricity supply before carrying out any work or maintenance on it.
- Connection to a good earth wiring system is essential and mandatory.
- Alterations to the domestic wiring system must only be made by a qualified electrician.
- Failure to follow this advice may result in electrical shock or death.

Cut Hazard

- Panel edges are sharp – be careful
- Failure to use caution could result in injury or cuts.

Important Safety Instructions

- After having unpacked the appliance, check to ensure that it is not damaged.
- No combustible material or products should be placed on this appliance at any time.
- In order to avoid hazard, this appliance must be installed according to the instructions for installation.
- This appliance is to be properly installed and earthed only by a suitably qualified person.
- Do not attempt to modify the technical characteristics of the appliance as this may become dangerous to use.
- This appliance should be connected to a circuit which incorporates an isolating switch providing full disconnection from the power supply.
- **WARNING:** Use only hob guards designed by the manufacturer of this appliance on the instructions for use. The use of inappropriate guards can cause accidents.
- Failure to install the appliance correctly could invalidate any warranty or liability claims.
- Regarding the details of installation, thanks to refer to the section <Installation>.

Operation and Maintenance

Electrical Shock Hazard

- Do not cook on a broken or cracked cooktop. If the cooktop surface is broken or cracked, switch the appliance off immediately at the main power supply (wall switch) to avoid the possibility of electric shock, for hob surfaces of glass-ceramic or similar material which protect live parts and contact customer service center.
- Switch the cooktop off at the wall before cleaning or maintenance.
- Failure to follow this advice may result in electrical shock or death.

Health Hazard

- This appliance complies with electromagnetic safety standards for domestic cooking. It should not interfere with another electronic unit.
- **WARNING:** Persons with cardiac pacemakers or any other electrical implants must check with their doctor if they can use the induction cooking system.

Hot Surface Hazard

- During use, the appliance and its accessible parts will become hot. Care should be taken to avoid touching the heating elements.

- Do not let your body, clothing or any item other than suitable cookware contact the ceramic glass until the surface is cool down.
- Children less than 8 years of age shall be kept away unless continuously supervised.
- Metallic objects such as knives, forks, spoons and lids should not be placed on the hob surface since they can get hot.
- Failure to follow this advice could result in burns and scalds.

Important Safety Instructions

- Never use the appliance as a work or storage surface.
- Never leave any objects or utensils on the appliance.
- Never use the appliance for warming or heating the room.
- After use, always turn off the cooking zones and the cooktop as described in this manual (i.e., by using the touch controls).
- The appliance is not intended to be operated by means of an external timer or separate remote-control system.
- Do not allow children to play with the appliance or sit, stand, or climb on it.
- Do not leave children alone or unattended in the area where the appliance is in use.
- Do not stand on the appliance.
- Do not repair or replace any part of the appliance unless specifically recommended in the manual. All other servicing should be done by a qualified technician.
- Do not use a steam cleaner to clean your cooktop as the moisture can get into the appliance therefore making it unsafe
- Do not place or drop heavy or sharp objects on the glass ceramic hob
- Do not use pans with jagged edges or drag pans across the glass surface as this can scratch the glass.
- Do not use scourers or any other harsh abrasive cleaning agents to clean your cooktop, as these can scratch the ceramic glass.
- Please use suitable cookware meant for induction cooking.
- Please use pans of recommended size (see minimum pan diameter in page 12). It is not advisable to use pans smaller than the cooking zone.
- If the supply cord is damaged, it must be replaced by the manufacturer, its service agent or similarly qualified persons in order to avoid hazard.
- This appliance can be used by children aged from 8 years and above and persons with reduced physical, sensory or mental capabilities or lack of experience and knowledge if they have been given supervision or instruction concerning use of the appliance in a safe way and understand the hazards involved.

- **WARNING:** Unattended cooking on a hob with fat or oil can be dangerous and may result in fire. NEVER try to extinguish a fire with water, but switch off the appliance and then cover flame e.g., with a lid or a fire blanket.
- **WARNING:** Danger of fire: do not store items on the cooking surfaces.

Advice for Installer

INSTALLATION

IMPORTANT:

- The cooktop is to be installed only by authorized person according to the current local regulations and in observation of the manufacturer's instructions.
- Incorrect installation, for which the manufacturer accepts no responsibility, may cause personal injury or damage.
- Always disconnect the cooktop from mains power supply before carrying out any maintenance operations or repairs

Product Dimensions

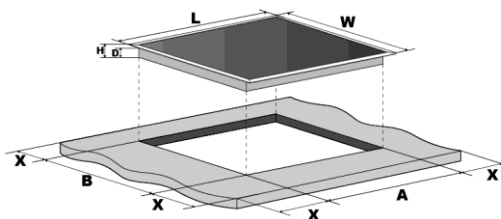

Fig.1

Model	L(mm)	W(mm)	H(mm)	D(mm)	A(mm)	B(mm)	X(mm)
HB BI 293 G	310	520	62	58	270	490	Min 50

Selection of Installation Equipment

- The cooktop must be housed in heat-resistant work surface to avoid large deformation caused by the heat radiation.
- Cut the work surface according to the dimension shown in the above table (Fig.1)
- A minimum of 50mm space shall be kept around the hole (refer to "X" in Fig.1)
- Be sure the thickness of the work surface is at least 30mm.
- The base of the cooktop must have direct unrestricted ventilation to the room where the cooktop is installed. **Follow the requirement of Fig. 2.**
- There must be a distance of at least 650mm between the cooktop and wall cupboard or hood



Under any circumstances, make sure the cooktop is well ventilated and the air inlet and outlet are not blocked. Ensure the cooktop is in good work state.

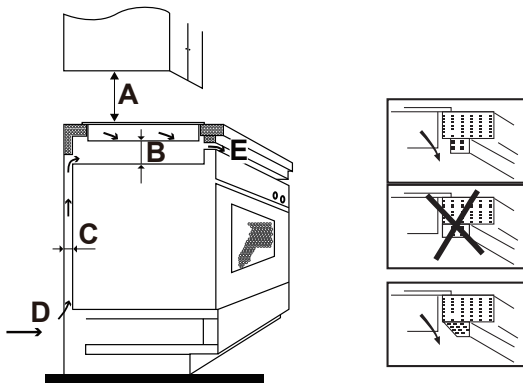

Fig.2

A	B	C	D	E (Air Exit)
650 mm	Min 50 mm	Min 30 mm	Air Intake	Min 5mm

X	100mm
Y	50mm



Note: The safe distance between the cooktop and any wall cupboard or cooker hood positioned immediate above the cooktop should be at least 650mm.

Before installing the hob, make sure that:

- The work surface is heat-resistant, square and level and no structural members interfere with space requirements.
- If the cooktop is installed above an oven, the oven should have a built-in cooling fan. The two appliances should be connected to the electrical supply with independent connections.
- The cooktop cannot be installed directly above cooling equipment, dishwasher or clothes dryers as the humidity may damage the cooktop electronic system.
- There is adequate air flow for the cooktop to fully function – the base of the cooktop must have direct unrestricted ventilation to the room where the cooktop is installed.
- To use heat-resistant and easy-to-clean finishes (such as ceramic tiles) for the wall surfaces surrounding the hob.
- If the hob is installed above a drawer or cupboard space, a thermal protection barrier is installed below the base of the hob.
- The installation shall comply with all clearance requirements and applicable standards and regulations.

- An approved isolating switch providing full disconnection from the main power supply is incorporated in the permanent wiring, mounted and positioned to comply with the local wiring rules and regulations.
- The isolating switch will be easily accessible to the customer with the hob installed.
- To consult local building authorities and by-laws if in doubt regarding installation.

SECURING THE HOB

Each cooktop is supplied with a set of installation fixture to help secure the cooktop onto the work surface from 30 to 50mm deep.

Installation fixtures

1. Sealing strip X 1
2. Bracket screws X 2
3. Bracket X 2

Before mounting the brackets

1. Turn the hob upside down and rest the glass on a cloth.
2. Apply the sealing strip around the edge of the hob shown.
3. Once the sealing strip has been applied ensure the ends do not overlap and then trim off any excess of the sealing strip and dispose it.

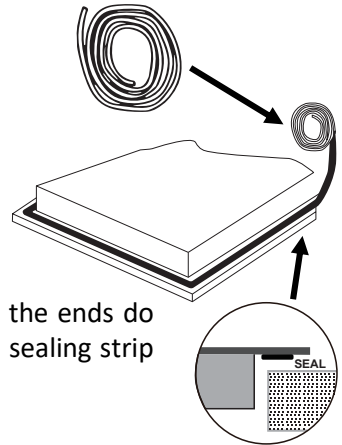

Mounting the brackets

Fix the 2x brackets on the side of the hob as seen below:

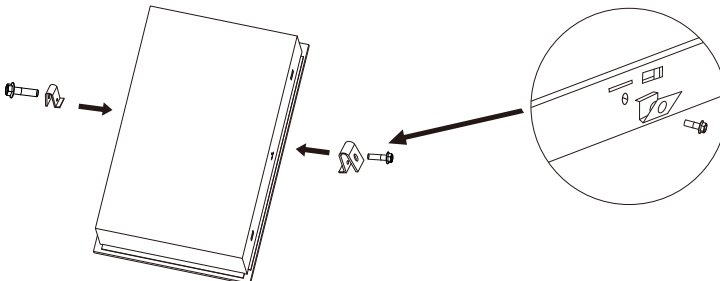

Installing the hob into the work surface

Place the hob into the cut-out hole and position it properly gently apply downward pressure on the hob to push it into the cut-out hole.

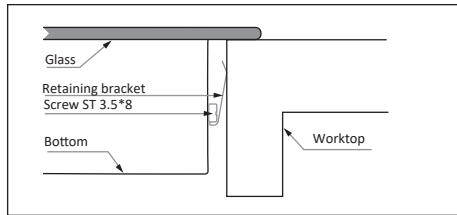

ELECTRICAL CONNECTION

The power supply should be connected in compliance with the relevant standard, or a single-pole circuit breaker. The method of connection is shown below.

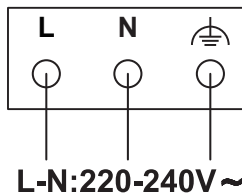

- Electric power connection shall be carried out only by a qualified personnel
- The cooktop must be connected to the mains checking that the voltage corresponds to the value given in the rating plate and that the electrical cable sections can withstand the load specified on the plate.
- If the appliance is being connected directly to the mains power supply, an omnipolar circuit breaker must be installed with a minimum gap of 3mm between the contacts.
- The cable must not near or touch any hot parts and must be positioned in such way that it does not exceed 50°C above ambient.
- If the cable is damaged or needs replacing, this should be done by an after-sales technician using proper tools.
- The cable must not be bent or compressed.
- The cable must be checked regularly and only replaced by a qualified personnel.

Note: Never use adaptors, reductions or multiple power points for electric power connection as these may overheat and catch fire.

Advice for User

PRODUCT OVERVIEW

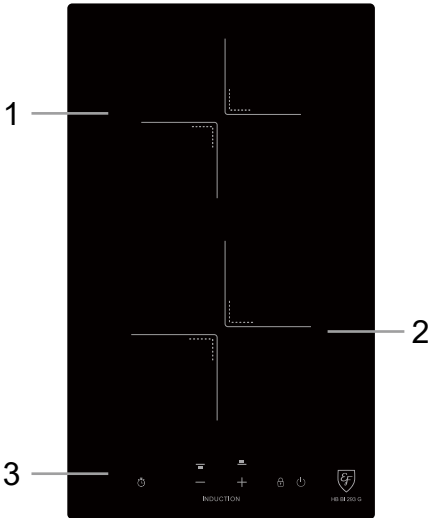

HB BI 293 G

1. Ø160mm / 1200 W zone
2. Ø180mm / 1700 W zone
3. Control panel

CONTROL PANEL

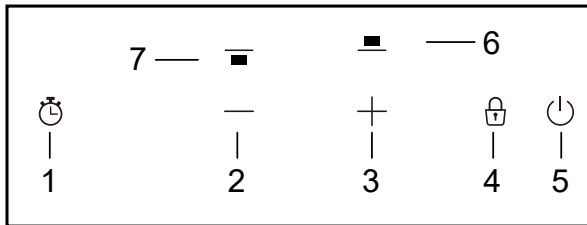

- | | |
|------------------------------------|------------------------------------|
| 1. Timer Key | 2. Decreasing Key (power or timer) |
| 3. Increasing Key (power or timer) | 4. Key Lock |
| 5. ON/OFF Key | 6. Zone Selection (Rear) |
| 7. Zone selection (Front) | |

USE OF INDUCTION HOB

Before using the induction hob, read this manual carefully and take note on the “Safety Guidelines” section.



Remove any protective film that may still be on the induction hob.

Induction Cooking System

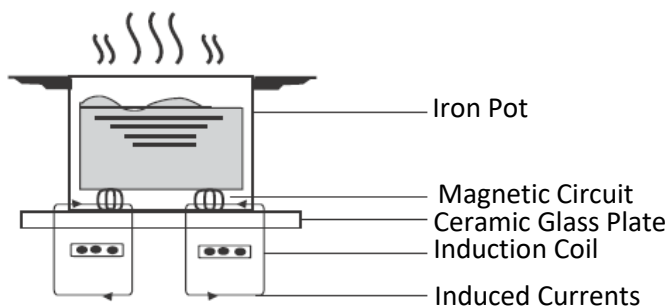
Induction cooking is a safe, advanced, efficient, and economical cooking technology. When cooking zone is selected, the electromagnetic circuit produce induced currents that instantly heat the bottom of the cookware which then transfer heat directly to the food. Cooking takes place with hardly any energy loss between the induction hob and food. The glass becomes hot only when the cookware eventually heats it up. Induction hob operates only if a correct pan with right features and dimension is placed on the cooking zone – refer to cookware selection for induction cooking.



Cookware for Induction Cooking

- Only use cookware with a base suitable for induction cooking. Look for the induction symbol “” on the packaging or at the bottom of the pan.
- Cookware made from the following materials is not suitable
 - Pure stainless steel, aluminum or copper without a magnetic base, glass, wood, porcelain, ceramic, and earthenware.
- To check if the cookware is suitable for induction,
 - Use a magnet. Put the magnet at the bottom of the base and if the magnet sticks, the cookware is suitable.
- If you do not have a magnet, put some water in the cookware you want to check and place on the cooking zone. Follow the steps under ‘To start cooking’. If the symbol “” does not appear on the display and the water is heating, the pan is suitable.



- The cooking zone will not operate if the cookware diameter is too small (the symbol “” will appear on the display. Follow the recommended cookware diameter given in the following table to correctly use the cooking zone.

Cooking Zone (mm)	Minimum cookware diameter recommended
Ø 180mm	140 mm
Ø 160mm	120 mm

Note: Some cookware available in the market is not in good quality or has an effective ferromagnetic area which is smaller than the diameter of the cookware itself. Avoid using this cookware as the induction cooktop may not function properly or it may cause damage to the cooktop.

Do not use cookware with jagged edges or a curved base.



Make sure that the base of your pan is smooth, sits flat against the glass, and is the same size as the cooking zone. Always center your pan on the cooking zone.

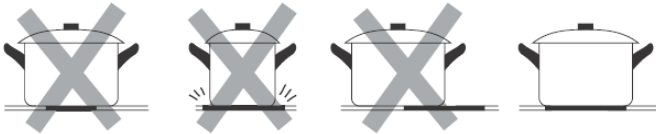

Always lift pans off the ceramic glass plate – do not slide, or they may scratch the glass.

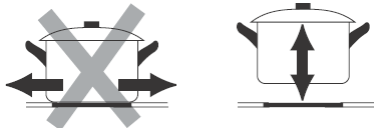

Note: Some type of cookware may cause noise during cooking – the noise is normal and does not mean any malfunction of the appliance.

Some induction cookware doesn't have a complete ferromagnetic base:

- If the material of the bottom of the cookware contains aluminum, the ferromagnetic area will also be reduced. This may mean that the cookware will not become hot enough or even be detected.

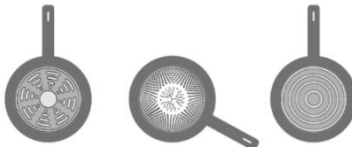

TOUCH CONTROL

This appliances comes with touch control system. Do take note on the following before using the hob.

Note:

- The control responds to touch, so you don't need to apply any pressure.
- Use the ball of your finger, not the tip.
- You will hear an acoustic sound each time a touch is registered.
- Make sure the control area is always clean, dry and that there is no object (e.g. a utensil or a cloth) covering them. Even a thin film of water may make the control difficult to operate.

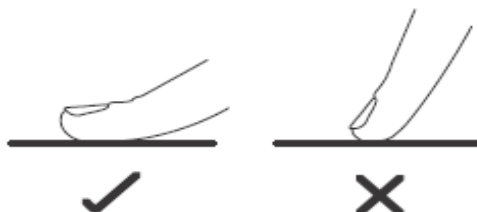

RESIDUAL HEAT WARNING

When the temperature of the cooking zone is still hot after the hob is switched off, the relevant letter “H” will be shown on the display as a warning of hot surface. Avoid touching the cooking zone until the temperate drops to a safe temperature and the letter “H” is turned off.

OVERHEAT PROTECTION

When overheating occurs, the cooking zone will display error code (refer to page 22) The induction hob will stop heating and no power will be delivered to the cooking zone.

Let the cooking zone cool down before using.

OVERFLOW PROTECTION

When the liquid flows to the control panel, the hob will automatically shut down within 10 seconds.

To restart, turn off the power and wipe the area with a clean towel before using.

OPERATION TIME LIMIT OF THE COOKING ZONE

Each cooking zone is switched off automatically after a maximum preset time if no further operation is performed. The maximum preset time limit depends on the set power level and the default cooking times are shown in the table below:

Power Level	1	2	3	4	5	6	7	8	9	P
Operation Time Limit (hour)	8	8	8	4	4	4	2	2	2	5min

Note: Each touch on the control key will reset the maximum operation time as initial default value.

OPERATION

TO START COOKING

Turn on the main power supply, the buzzer beeps once and all the indicators light up for 1 second then goes off, indicating that the hob has entered the state of standby mode.

1. Place a suitable pan on the desired cooking zone (Top or bottom zone) and tap the ON/OFF control . The buzzer will beep once and all the indicators show “_”

Note: make sure the bottom of the pan and the surface of the cooking zone is clean and dry

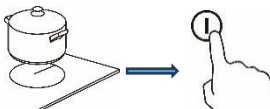

2. Select the cooking zone by tapping the relevant heating zone, the power level on the selected zone will flash. Default power level setting is “5”.
3. Adjust the heat setting by tapping the key “+” or “-”

Note:

- Adjustment on the selected zone can be done only while the power level indicator is in “blinking” mode.
- If a cooking zone is not turned on within 1 minute, the induction hob will automatically switch off.

TO END COOKING

Select the cooking zone that you wish to turn off by tapping the relevant heating zone, then set the power level to " 0 " or you can tap the relevant ON/OFF control to switch off both zone.



Note: Beware of hot surfaces!

"H" will be lighted for cooking zone which is hot to touch. It will be turned off when the cooking zone temperature drops below a preset temperature. It can also be used as an energy saving function as you can heat up the pans by using the residual heat.



SAFETY KEY LOCK

This function locks the touch control key to prevent unintended use, for example, to prevent children accidentally switching on the cooking zones.

When the safety key lock is activated, all the controls except the ON/OFF key are disabled.

To activate the key-lock

Tap the key lock control  once, the timer indicator will show "LO" and the key-lock is activated.

To deactivate the key-lock

Tap and hold the key lock control  for 3 seconds until the display "LO" disappears.



When the hob is in lock mode, all the controls are disabled except the ON/OFF key, you can always turn off the hob with the ON/OFF control. To use the cooktop after it is switched off, key-lock protection has to be deactivated first.

TIMER FUNCTION

The timer can be used in two different ways:

Minute Minder	Cooking Timer
6	6 

- As a **minute minder** - the timer will not turn any cooking zone off when the set time is up. It works as a reminder or alarm.
- As an **automatic switch off timer** - to turn the cooking zones off after the set time is up.
- In both ways, the timer can be set from “1 min **(01)** to 99mins **(99)** “

Note:

- The default timer display is “**10**”.
- Adjustment of time can be done only while the timer display is in flashing mode.

Using the Timer as Minute Minder

The minute minder can be activated if no heat setting is done on the cooking zone

1. Make sure the hob is turned ON.

Note: The minute minder can be activated before or after cooking zone setting is finished.

2. Tap the timer key, the timer display will show “ 10 minutes ” by default and the second digit “0” will start blinking (Each single digit has to be configured individually.)

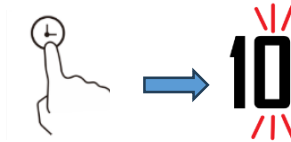

3. Within 5 seconds, set the timer using “ + ” or “ - ” to select the required time. Each tap on the timer key will shift the timer adjustment from second digit to first.



4. When the time is set, it will begin to count down immediately. The display will show the remaining time.

5. Buzzer will beep and the time display will show “ - - ”

6. When the setting time is up. Cooking will still be continued without cut off.

Note: Remember to switch off the cooking zone manually.

Using the Timer as Automatic Switch Off Timer

1. Select the heating zone and set the desired power level.
2. Tap the timer key on the selected zone, the timer display “10 minutes ” by default and the second digit “0” will start blinking (Each single digit has to be configured individually).

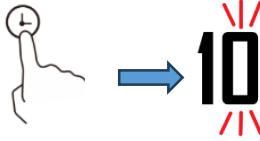

3. Within 5 seconds, set the timer using “+” or “-” to select the required time. Each tap on the timer key will shift the timer adjustment from second digit to first.

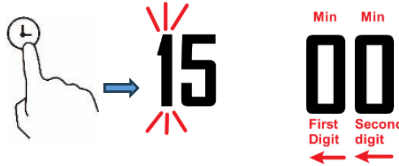

The duration of the timer set according to power level as below:

Power Level	1	2	3	4	5	6	7	8	9
Optional working time (minute)	00 - 99								

4. The program is now processed and the cut off timer will count down immediately. The display will show the remaining timer and a red dot next to the power level indicator will be lighted, indicating that relevant zone is selected for timer.
5. When cooking timer has ended, the relevant cooking zone will switch off automatically and the time display will show “ - - “. Other cooking zones will keep operating if they are turned on previously.

Note: The time can be changed at any time by tapping the timer control key.

To cancel the timer, select the relevant cooking zone with timer set, then tap the timer key, the time display will flash. Reset the time to “00” using “+” or “-”.



HEAT SETTING

Heat Setting	Suitability
1 - 2	<ul style="list-style-type: none">• Delicate warming for small amounts of food• Melting chocolate, butter and food that burn quickly• Gentle simmering
3 - 4	<ul style="list-style-type: none">• Reheating• Simmering
5 - 6	<ul style="list-style-type: none">• Slow boiling• Steaming
7 - 8	<ul style="list-style-type: none">• Frying• Browning of meats• Boiling of water
9	<ul style="list-style-type: none">• Fast frying• Fast boiling• Grilled steaks

CARE AND MAINTENANCE

Problem	Action	Remarks
Soiling on glass (fingerprints, marks, stains left by food or non-sugary spillovers on the glass)	<ol style="list-style-type: none"> 1. Switch off the main power of the cooktop. 2. Apply a cooktop cleaner while the glass is still warm (but not hot!) 3. Rinse and wipe dry with a clean cloth or paper towel. 	<ul style="list-style-type: none"> • When the power of the cooktop is switched off, there will be no 'hot surface' indication but the cooking zone may still be hot! Take extreme care. • Heavy-duty scourers, some nylon scourers and harsh/abrasive cleaning agents may scratch the glass. Always read the label to check if the cleaner or scourer is suitable. • Never leave cleaning residue on the cooktop: the glass may become stained
Boil overs, melts, and hot sugary spills on the glass	<p>Remove these immediately with a fish slice, palette knife or razor blade scraper suitable for ceramic glass cooktops, but beware of hot cooking zone surfaces:</p> <ol style="list-style-type: none"> 1. Switch off the main power 2. Hold the blade or utensil at a 30° angle and scrape the soiling or spill to a cool area of the cooktop. 3. Clean the soiling or spillages with a dish cloth or paper towel. 4. Follow steps 2 to 4 for 'Soiling on glass as above. 	<ul style="list-style-type: none"> • Stains must be removed as soon as possible. If the stain remains unclean and become harder, it will be difficult to remove or even permanently damage the glass surface. • Cut hazard: when the safety cover is retracted, the blade in a scraper is razor-sharp. Use with extreme care and always store safely and keep out of reach of children.
Spillovers on the touch controls	<ol style="list-style-type: none"> 1. Switch off the main power. 2. Wipe the touch control area with a clean damp sponge or cloth. 3. Wipe the area completely dry with a paper towel. 4. Switch the power on. 	<ul style="list-style-type: none"> • The cooktop may beep and turn itself off. The touch controls may not function while there is liquid on it. Make sure you wipe the touch control area dry before turning the cooktop power on.

WARNING:

When correctly installed, the product meets all safety requirements laid down for this type of product category. However, special care should be taken around the underneath of the product as this area is not designed or intended to be touched and may contain sharp or rough edges that may cause injury

TROUBLE SHOOTING

Problem	Possible causes	Action
The cooktop cannot be turned on.	<ul style="list-style-type: none"> No power. 	<ul style="list-style-type: none"> Make sure the cooktop is connected to the power supply and is switched on. Check whether there is power outage
The touch controls are not responsive.	<ul style="list-style-type: none"> The controls are locked. 	<ul style="list-style-type: none"> Unlock the controls. See section 'Safety Key-lock' for instructions.
The touch control is difficult to operate.	<ul style="list-style-type: none"> There may be a spillage of water over the controls or you may be using the tip of your finger when touching the controls. 	<ul style="list-style-type: none"> Make sure the touch control area is dry Use the ball of your finger when touching the controls.
Scratch mark on the surface	<ul style="list-style-type: none"> Rough-edged cookware. Unsuitable, abrasive scourer or cleaning products being used. 	<ul style="list-style-type: none"> Use cookware with flat and smooth base. See 'Choosing the right cookware'. See 'Care and cleaning'.
Some cookware make crackling or clicking noises.	<ul style="list-style-type: none"> This may be caused by the construction of your cookware (Layers of different metals vibrating differently). 	<ul style="list-style-type: none"> This is normal and does not indicate a fault.
The induction hob makes a low humming noise when used on a high heat setting.	<ul style="list-style-type: none"> This is due to the normal operation of the electronic control system 	<ul style="list-style-type: none"> This is normal but the noise should be reduced or disappear completely when heat setting is reduced.
Fan noise coming from the induction hob.	<ul style="list-style-type: none"> A cooling fan built into your induction hob is activated to prevent the electronics from overheating. It may continue to run even after you've turned off the induction hob. 	<ul style="list-style-type: none"> This is normal and needs no action. Do not switch off the main power while the fan is running.
Pans do not heat up and appears in the display.	<ul style="list-style-type: none"> Pan cannot be detected as it is not suitable for induction cooking. Pan is too small for the cooking zone or not properly centered 	<ul style="list-style-type: none"> Use cookware suitable for induction cooking. See section 'Choosing the right cookware'. Centre the pan and make sure that its base matches the size of the cooking zone.

<p>The induction hob or a cooking zone switch off unexpectedly, an acoustic signal sounded and an error code is displayed (typically alternating with one or two digits in the cooking timer display).</p>	<ul style="list-style-type: none">• Technical fault.	<ul style="list-style-type: none">• Please note down the error code, switch off the main power of the induction hob and contact customer service center.
--	--	--

FAILURE DISPLAY AND INSPECTION

The cooktop is fitted with safety devices to protect the electronic system and if an abnormality occurs, the cooktop will enter into protective state automatically and the following error codes will show:

Problem	Possible Causes	Action
E1	Signal Lost (PCB Failure)	Contact customer service centre
E2/E3	Abnormal High/Low input voltage	Check the incoming power supply. Turn on power after the power supply is back to normal.
E4 / E5 / E6	Thermistor failure.	Contact customer service centre
E7	Abnormal high temperature (dry burning)	Switch off the power, wait for 30min and then switch on. If it is still not working, please contact service centre.
E9	Failure of IGBT sensor	Contact customer service centre
E0	IGBT Overheat	Check if the fan is still working. If not please contact service centre to repair.
EE	Display PCB failure.	Contact customer service centre

Note: Please do not disassemble the unit by yourself to avoid any dangers and damages to the induction hob.

TECHNICAL SPECIFICATION

Model No:	HB BI 293 G
Cooking Zones	2
Electric Supply	220-240V~ / 50-60Hz
Total Electric Power	2900W
Product Dimensions L x W x H	310mm x 520mm x 62mm
Built-In Dimensions L x W	270mm x 490mm



DISPOSAL: Do not dispose this product as unsorted municipal waste. Collection of such waste separately for special treatment is necessary.

This appliance is labeled in compliance with European directive 2012/19/EU for Waste Electrical and Electronic Equipment (WEEE). By ensuring that this appliance is disposed of correctly, you will help prevent any possible damage to the environment and to human health, which might otherwise be caused if it were disposed of in the wrong way.

The symbol on the product indicates that it may not be treated as normal household waste. It should be taken to a collection point for recycling of electrical and electronic goods.

This appliance requires specialist waste disposal. For further information regarding the treatment, recovery and recycling of this product please contact your local council, your household waste disposal service, or the shop where you purchased it.

For more detailed information about treatment, recovery and recycling of this product, please contact your local city office, your household waste disposal service or the shop where you purchased the product.

WARRANTY AND SERVICE

- To activate your warranty, please register your appliance.
- Warranty registration can be done via our website or scan the QR code below

Website

<https://shop.casa.sg/E-Warranty>

QR Code

Scan the QR Code below. It will redirect straight to our “Warranty Registration” page.



Casa (S) Pte Ltd. reserves the rights to the final interpretation of the content of this manual. Customer will not be notified in the event of any amendments to the content.

The manufacturer and agent decline all responsibilities in the event of damage caused by improper, incorrect or illogical use of the appliance.

Contact customer care center when in doubt of the condition of the appliance. Please get ready the model number of your appliance, date of purchase and the product issue when contacting customer care center.

For customer care / after sales service [Singapore], please contact

Casa (S) Pte Ltd

15, Kian Teck Crescent, Singapore 628884

Whatsapp: +65 9747 8743

Fax: +65 6898 0510

Email: service@casa.com.sg